

Price List

Stainless Steel Drainage Systems, Pipe & Channels

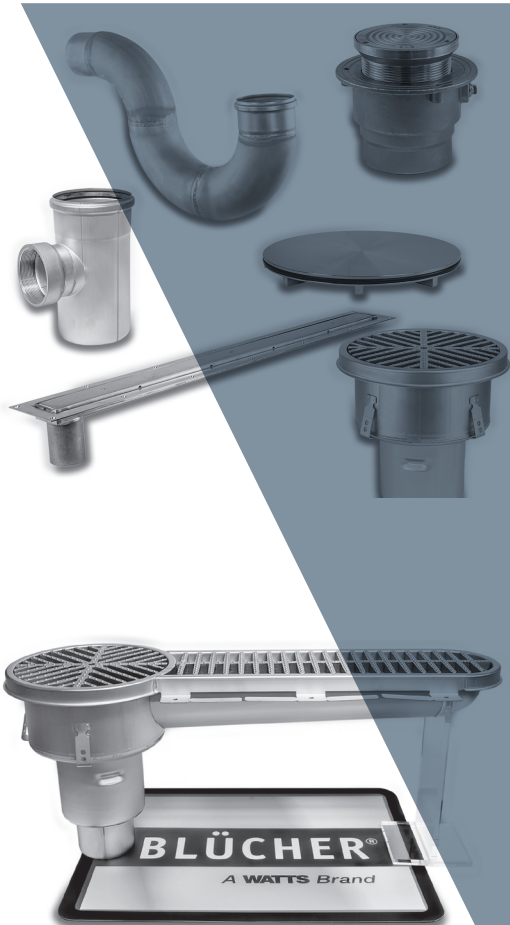
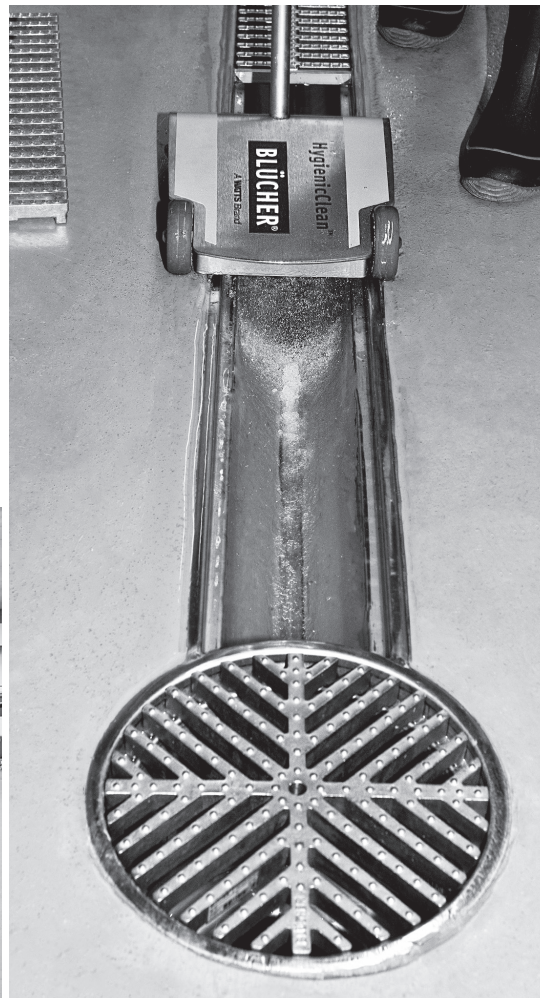

Effective January 8, 2024

All prices supersede previous issues, are temporary and subject to change without notice.

Table of Contents

Terms & Conditions of Sale	2
Push-Fit Stainless Steel Pipe & Fittings.	3-16
Straight Pipe with One Socket	3-4
Bends & Tees	5-7
Wyes & Access Pipes.	8-9
Increases & Reducers	10
Double Couplings & Expansion Sockets.	11
Adapters.	12
Sealings Rings & Transition Couplings	13
Traps.	14
Dual Containment, Adapters & Welding Sleeves	15-16
Clamps, Hangers, Socket Plugs & Cutting Tools & Accessories	17-18
HygienicPro® Floor Drains & Channels	19-20
HygienicPro® Floor Drains	19
HygienicPro® Channel, Options & Accessories	20
Trench Drains.	21-22
BT Series & Options	21
BT Series Accessories & Gratings	22
BTS Series & Options	22
8" Adjustable & Sanitary Floor Drains	23-27
BFD-610 Gastight Floor Drains & Options.	26
BFD-110, BFD-210, BFD-310, BFD-410, BFD-320 & BFD-420 Series.	23-24
BFD-510 Series, BFD-550 Series & BFD Optional Gratings.	25-26
12" Adjustable & Sanitary Floor Drains	27-29
BFD-130, BFD-230, BFD-340, BFD-440, BFD-530 & BFD-560 Series.	27
BFD Series Optional Gratings & Options	29
BHD-200	31
Cleanouts	30-31
BCO Series.	30-31
BWCO Series & BTPC Series	31
Kitchen Channels	32
BKC Series & Options	32
Lavatory/Shower Drains & Channels.	33-34
BSS Series & BSR Series	33
BWC Series, BWS Series & Options	34
Marine Fittings.	35-37
Adapters	35
Penetrations & Bends	36-37
Marine Drains	38-39
Lower Parts	38
Upper Parts, Water Traps & Replacement Gratings	39

BLÜCHER Terms & Conditions

FREIGHT TERMS:

Shipments from the factory of less than \$5,000.00 net are F.O.B. factory. Factory shipments over \$5,000.00 net will be prepaid and allowed within the continental United States when made at the lowest motor carrier transportation rate.

TERMS OF SALE:

All sales within the United States or within Canada are F.O.B. (shipping point). All international sales are F.O.B. (origin port).

PAYMENT TERMS:

Invoices are due and payable 30 days from the date of invoice. A 2% cash discount is allowed on net amount of invoice if paid on or before the 10th of the following month. Invoices dated on or after the 25th will be considered as dated the first of the next month.

PURCHASE ORDER FORMS:

Orders submitted on customer's own purchase order forms will be accepted only with the express understanding that no statements, clauses, or conditions contained in said order form will be binding on the seller if they in any way modify the seller's own terms and conditions of sales.

STOCKING WHOLESALE MINIMUM CHARGE:

A minimum billing charge of \$75.00 applies to shipments F.O.B. factory. Stocking Wholesaler Customers are encouraged to order sufficient material to avoid this charge which is necessitated by increased costs of processing small orders.

SPECIAL PRODUCTS:

Orders for special or modified products are non-cancelable and non-returnable. In the event that the customer cancels an order for such products, BLÜCHER shall charge the customer an amount equal to BLÜCHER'S costs and expenses incurred in performing the purchase order prior to receipt of notice of cancellation.

LIMITED WARRANTY:

BLÜCHER (the "Company") warrants each product to be free from defects in material and workmanship under normal usage for a period of one year from the date of original shipment. In the event of such defects within the warranty period, the Company will, at its option, replace or recondition the product without charge. THE WARRANTY SET FORTH HEREIN IS GIVEN EXPRESSLY AND IS THE ONLY WARRANTY GIVEN BY THE COMPANY WITH RESPECT TO THE PRODUCT. THE COMPANY MAKES NO OTHER WARRANTIES, EXPRESS OR IMPLIED. THE COMPANY HEREBY SPECIFICALLY DISCLAIMS ALL OTHER WARRANTIES, EXPRESS OR IMPLIED, INCLUDING BUT NOT LIMITED TO THE IMPLIED WARRANTIES OF MERCHANTABILITY AND FITNESS FOR A PARTICULAR PURPOSE.

The remedy described in the first paragraph of this warranty shall constitute the sole and exclusive remedy for breach of warranty, and the Company shall not be responsible for any incidental, special or consequential damages, including without limitation, lost profits or the cost of repairing or replacing other property which is damaged if this product does not work properly, other costs resulting from labor charges, delays, vandalism, negligence, fouling caused by foreign material, damage from adverse water conditions, chemical, or any other circumstances over which the Company has no control. This warranty shall be invalidated by any abuse, misuse, misapplication, improper installation or improper maintenance or alteration of the product.

Some States do not allow limitations on how long an implied warranty lasts, and some States do not allow the exclusion or limitation of incidental or consequential damages. Therefore the above limitations may not apply to you. This Limited Warranty gives you specific legal rights, and you may have other rights that vary from State to State. You should consult applicable state laws to determine your rights. SO FAR AS IS CONSISTENT WITH APPLICABLE STATE LAW, ANY IMPLIED WARRANTIES THAT MAY NOT BE DISCLAIMED, INCLUDING THE IMPLIED WARRANTIES OF MERCHANTABILITY AND FITNESS FOR A PARTICULAR PURPOSE, ARE LIMITED IN DURATION TO ONE YEAR FROM THE DATE OF ORIGINAL SHIPMENT.

RETURNED GOODS RESTOCKING CHARGE:

No material shall be returned without authorization. Returns are limited to a maximum of 10% of the total Purchase Order value. When credit is issued it will be at the price charged, or prevailing price if lower, less handling charges based on costs of reconditioning, boxing, etc. However, a minimum 25% handling charge will apply. A minimum handling charge of \$35.00 is applied whenever the 25% handling deduction does not total \$35.00. Products which are obsolete or made to special order are not returnable.

NOTE:

Prices and terms are subject to change without notice and supersede all previous quotations. BLÜCHER reserves the right to change or modify product design or construction without prior notice and without incurring any obligation to make such changes and modifications on products previously or subsequently sold. All dimensions shown in this catalog are subject to manufacturing tolerances. See your **BLÜCHER** representative for any clarification.

Straight Pipe With One Socket



Straight Pipe - One Socket - 1-1/2"(40) Diameter

Ordering Code	Model	Size/Description	UPC	Wt. (lbs)	List Price
811.015.040 S	P1.5-0.5-316	1-1/2"(40) D x 5-7/8"(150) L SS Straight Pipe	098268177794	0.44	\$56.25
811.025.040 S	P1.5-0.8-316	1-1/2"(40) D x 9-13/16"(250) L SS Straight Pipe	098268178456	0.63	71.50
811.050.040 S	P1.5-1.6-316	1-1/2"(40) D x 1'-7-11/16"(500) L SS Straight Pipe	098268178524	1.50	121.00
811.075.040 S	P1.5-2.5-316	1-1/2"(40) D x 2'-5-1/2"(750) L SS Straight Pipe	098268178692	1.72	160.00
811.100.040 S	P1.5-3.3-316	1-1/2"(40) D x 3'-3-3/8"(1000) L SS Straight Pipe	098268179392	2.25	187.50
811.150.040 S	P1.5-4.9-316	1-1/2"(40) D x 4'-11-1/8"(1500) L SS Straight Pipe	098268178951	3.31	250.50
811.200.040 S	P1.5-6.6-316	1-1/2"(40) D x 6'-6-11/16"(2000) L SS Straight Pipe	098268179408	4.39	331.00
811.300.040 S	P1.5-9.8-316	1-1/2"(40) D x 9'-10-1/8"(3000) L SS Straight Pipe	098268179781	6.53	458.00

Straight Pipe - One Socket - 2"(50) Diameter

Ordering Code	Model	Size/Description	UPC	Wt. (lbs)	List Price
811.015.050 S	P2-0.5-316	2"(50) D x 5-7/8"(150) L SS Straight Pipe	098268177930	0.55	\$65.25
811.025.050 S	P2-0.8-316	2"(50) D x 9-13/16"(250) L SS Straight Pipe	098268179354	0.84	86.50
811.050.050 S	P2-1.6-316	2"(50) D x 1'-7-11/16"(500) L SS Straight Pipe	098268178562	1.50	130.50
811.075.050 S	P2-2.5-316	2"(50) D x 2'-5-1/2"(750) L SS Straight Pipe	098268178715	2.21	187.50
811.100.050 S	P2-3.3-316	2"(50) D x 3'-3-3/8"(1000) L SS Straight Pipe	098268178852	2.76	237.50
811.150.050 S	P2-4.9-316	2"(50) D x 4'-11-1/8"(1500) L SS Straight Pipe	098268178975	4.19	323.50
811.200.050 S	P2-6.6-316	2"(50) D x 6'-6-11/16"(2000) L SS Straight Pipe	098268179415	5.40	416.50
811.300.050 S	P2-9.8-316	2"(50) D x 9'-10-1/8"(3000) L SS Straight Pipe	098268179798	8.42	589.50

Straight Pipe - One Socket - 3"(75) Diameter

Ordering Code	Model	Size/Description	UPC	Wt. (lbs)	List Price
811.015.075 S	P3-0.5-316	3"(75) D x 5-7/8"(150) L SS Straight Pipe	098268177947	0.90	\$71.00
811.025.075 S	P3-0.8-316	3"(75) D x 9-13/16"(250) L SS Straight Pipe	098268178463	1.28	93.75
811.050.075 S	P3-1.6-316	3"(75) D x 1'-7-11/16"(500) L SS Straight Pipe	098268178586	2.21	144.00
811.075.075 S	P3-2.5-316	3"(75) D x 2'-5-1/2"(750) L SS Straight Pipe	098268178722	3.31	213.00
811.100.075 S	P3-3.3-316	3"(75) D x 3'-3-3/8"(1000) L SS Straight Pipe	098268178869	4.30	265.00
811.150.075 S	P3-4.9-316	3"(75) D x 4'-11-1/8"(1500) L SS Straight Pipe	098268178982	6.06	378.00
811.200.075 S	P3-6.6-316	3"(75) D x 6'-6-11/16"(2000) L SS Straight Pipe	098268179422	8.16	474.50
811.300.075 S	P3-9.8-316	3"(75) D x 9'-10-1/8"(3000) L SS Straight Pipe	098268179804	12.74	633.50

Straight Pipe - One Socket - 4"(110) Diameter

Ordering Code	Model	Size/Description	UPC	Wt. (lbs)	List Price
811.015.110 S	P4-0.5-316	4"(110) D x 5-7/8"(150) L SS Straight Pipe	098268177954	1.35	\$93.75
811.025.110 S	P4-0.8-316	4"(110) D x 9-13/16"(250) L SS Straight Pipe	098268178487	1.92	115.50
811.050.110 S	P4-1.6-316	4"(110) D x 1'-7-11/16"(500) L SS Straight Pipe	098268178647	3.31	208.50
811.075.110 S	P4-2.5-316	4"(110) D x 2'-5-1/2"(750) L SS Straight Pipe	098268178739	4.74	273.00
811.100.110 S	P4-3.3-316	4"(110) D x 3'-3-3/8"(1000) L SS Straight Pipe	098268178876	6.28	345.00
811.150.110 S	P4-4.9-316	4"(110) D x 4'-11-1/8"(1500) L SS Straight Pipe	098268178999	9.48	488.50
811.200.110 S	P4-6.6-316	4"(110) D x 6'-6-11/16"(2000) L SS Straight Pipe	098268179439	11.91	627.50
811.300.110 S	P4-9.8-316	4"(110) D x 9'-10-1/8"(3000) L SS Straight Pipe	098268179866	18.39	825.00

Straight Pipe With One Socket



Straight Pipe - One Socket - 5"(125) Diameter

Ordering Code	Model	Size/Description	UPC	Wt. (lbs)	List Price
811.015.125 S	P5-0.5-316	5"(125) D x 5-7/8"(150) L SS Straight Pipe	098268178197	1.55	\$115.50
811.025.125 S	P5-0.8-316	5"(125) D x 9-13/16"(250) L SS Straight Pipe	098268180114	2.23	159.00
811.050.125 S	P5-1.6-316	5"(125) D x 1'-7-11/16"(500) L SS Straight Pipe	098268180138	3.93	223.00
811.075.125 S	P5-2.5-316	5"(125) D x 2'-5-1/2"(750) L SS Straight Pipe	098268178746	5.63	291.50
811.100.125 S	P5-3.3-316	5"(125) D x 3'-3-3/8"(1000) L SS Straight Pipe	098268178883	7.32	364.00
811.150.125 S	P5-4.9-316	5"(125) D x 4'-11-1/8"(1500) L SS Straight Pipe	098268179002	10.72	681.50
811.200.125 S	P5-6.6-316	5"(125) D x 6'-6-11/16"(2000) L SS Straight Pipe	098268179620	14.11	732.00
811.300.125 S	P5-9.8-316	5"(125) D x 9'-10-1/8"(3000) L SS Straight Pipe	098268179880	20.88	934.50

Straight Pipe - One Socket - 6"(160) Diameter

Ordering Code	Model	Size/Description	UPC	Wt. (lbs)	List Price
811.015.160 S	P6-0.5-316	6"(160) D x 5-7/8"(150) L SS Straight Pipe	098268178203	2.62	\$166.00
811.025.160 S	P6-0.8-316	6"(160) D x 9-13/16"(250) L SS Straight Pipe	098268178494	3.73	208.50
811.050.160 S	P6-1.6-316	6"(160) D x 1'-7-11/16"(500) L SS Straight Pipe	098268178654	6.53	338.00
811.075.160 S	P6-2.5-316	6"(160) D x 2'-5-1/2"(750) L SS Straight Pipe	098268178760	9.30	502.50
811.100.160 S	P6-3.3-316	6"(160) D x 3'-3-3/8"(1000) L SS Straight Pipe	098268178890	12.08	595.50
811.150.160 S	P6-4.9-316	6"(160) D x 4'-11-1/8"(1500) L SS Straight Pipe	098268179019	17.68	768.00
811.200.160 S	P6-6.6-316	6"(160) D x 6'-6-11/16"(2000) L SS Straight Pipe	098268179637	23.24	1,005.00
811.300.160 S	P6-9.8-316	6"(160) D x 9'-10-1/8"(3000) L SS Straight Pipe	098268179927	34.37	1,435.00

Straight Pipe - One Socket - 8"(200) Diameter

Ordering Code	Model	Size/Description	UPC	Wt. (lbs)	List Price
811.015.200 S	P8-0.5-316	8"(200) D x 5-7/8"(150) L SS Straight Pipe	098268178210	4.32	\$297.50
811.025.200 S	P8-0.8-316	8"(200) D x 9-13/16"(250) L SS Straight Pipe	098268178517	6.11	385.50
811.050.200 S	P8-1.6-316	8"(200) D x 1'-7-11/16"(500) L SS Straight Pipe	098268178661	10.19	589.00
811.075.200 S	P8-2.5-316	8"(200) D x 2'-5-1/2"(750) L SS Straight Pipe	098268178845	14.26	764.00
811.100.200 S	P8-3.3-316	8"(200) D x 3'-3-3/8"(1000) L SS Straight Pipe	098268178906	18.34	954.00
811.200.200 S	P8-6.6-316	8"(200) D x 6'-6-11/16"(2000) L SS Straight Pipe	098268179644	34.64	1,435.00
811.300.200 S	P8-9.8-316	8"(200) D x 9'-10-1/8"(3000) L SS Straight Pipe	098268179965	50.93	2,039.00

Straight Pipe - One Socket - 10"(250) Diameter

Ordering Code	Model	Size/Description	UPC	Wt. (lbs)	List Price
811.050.250 S	P10-1.6-316	10"(250) D x 1'-7-11/16"(500) L SS Straight Pipe	098268178678	12.88	\$908.00
811.100.250 S	P10-3.3-316	10"(250) D x 3'-3-3/8"(1000) L SS Straight Pipe	098268178920	23.08	1,578.00
811.200.250 S	P10-6.6-316	10"(250) D x 6'-6-11/16"(2000) L SS Straight Pipe	098268179651	43.48	2,581.00
811.300.250 S	P10-9.8-316	10"(250) D x 9'-10-1/8"(3000) L SS Straight Pipe	098268180008	63.87	3,729.00

Straight Pipe - One Socket - 12"(315) Diameter

Ordering Code	Model	Size/Description	UPC	Wt. (lbs)	List Price
811.050.315 S	P12-1.6-316	12"(315) D x 1'-7-11/16"(500) L SS Straight Pipe	098268178685	21.89	\$1,775.00
811.100.315 S	P12-3.3-316	12"(315) D x 3'-3-3/8"(1000) L SS Straight Pipe	098268178944	39.02	3,585.00
811.200.315 S	P12-6.6-316	12"(315) D x 6'-6-11/16"(2000) L SS Straight Pipe	098268179750	73.28	4,914.00
811.300.315 S	P12-9.8-316	12"(315) D x 9'-10-1/8"(3000) L SS Straight Pipe	098268180091	107.52	6,882.00

Bends

15° Bends



Ordering Code	Model	Size/Description	UPC	Wt. (lbs.)	List Price
820.015.040 S	B1.5-15-316	1-1/2"(40) 15° Stainless Steel Bend	098268189537	0.27	\$60.00
820.015.050 S	B2-15-316	2"(50) 15° Stainless Steel Bend	098268192292	0.34	66.50
820.015.075 S	B3-15-316	3"(75) 15° Stainless Steel Bend	098268192308	0.62	86.50
820.015.110 S	B4-15-316	4"(110) 15° Stainless Steel Bend	098268192315	1.04	118.50
820.015.125 S	B5-15-316	5"(125) 15° Stainless Steel Bend	098268192322	1.24	316.50
820.015.160 S	B6-15-316	6"(160) 15° Stainless Steel Bend	098268188059	2.38	321.50
820.015.200 S	B8-15-316	8"(200) 15° Stainless Steel Bend	098268192346	4.39	458.00
820.015.250 S	B10-15-316	10"(250) 15° Stainless Steel Bend	098268192360	6.69	800.50
820.015.315 S	B12-15-316	12"(315) 15° Stainless Steel Bend	098268192377	12.13	1,624.00

30° Bends



Ordering Code	Model	Size/Description	UPC	Wt. (lbs.)	List Price
820.030.040 S	B1.5-30-316	1-1/2"(40) 30° Stainless Steel Bend	098268192544	0.29	\$66.50
820.030.050 S	B2-30-316	2"(50) 30° Stainless Steel Bend	098268192551	0.36	77.75
820.030.075 S	B3-30-316	3"(75) 30° Stainless Steel Bend	098268192568	0.62	86.50
820.030.110 S	B4-30-316	4"(110) 30° Stainless Steel Bend	098268192575	1.13	118.50
820.030.125 S	B5-30-316	5"(125) 30° Stainless Steel Bend	098268192605	1.39	314.00
820.030.160 S	B6-30-316	6"(160) 30° Stainless Steel Bend	098268192612	2.54	394.50
820.030.200 S	B8-30-316	8"(200) 30° Stainless Steel Bend	098268192636	4.86	610.50
820.030.250 S	B10-30-316	10"(250) 30° Stainless Steel Bend	098268192643	7.39	929.50
820.030.315 S	B12-30-316	12"(315) 30° Stainless Steel Bend	098268192650	13.63	1,743.00

45° 1/8 Bends



Ordering Code	Model	Size/Description	UPC	Wt. (lbs.)	List Price
820.045.040 S	B1.5-45-316	1-1/2"(40) 45° Stainless Steel Bend	098268192667	0.29	\$76.50
820.045.050 S	B2-45-316	2"(50) 45° Stainless Steel Bend	098268192674	0.38	86.50
820.045.075 S	B3-45-316	3"(75) 45° Stainless Steel Bend	098268192742	0.66	98.00
820.045.110 S	B4-45-316	4"(110) 45° Stainless Steel Bend	098268192865	1.24	128.00
820.045.125 S	B5-45-316	5"(125) 45° Stainless Steel Bend	098268192872	1.61	164.50
820.045.160 S	B6-45-316	6"(160) 45° Stainless Steel Bend	098268192889	3.42	394.50
820.045.200 S	B8-45-316	8"(200) 45° Stainless Steel Bend	098268192896	5.25	1,065.00
820.045.250 S	B10-45-316	10"(250) 45° Stainless Steel Bend	098268192902	8.14	2,366.00

90° 1/4 Bends



Ordering Code	Model	Size/Description	UPC	Wt. (lbs.)	List Price
820.090.040 S	B1.5-90-316	1-1/2"(40) 90° Stainless Steel Bend	098268192919	0.34	\$110.00
820.090.050 AS	B2-90-316	2"(50) 90° Stainless Steel Bend	098268193107	0.47	121.00
820.090.075 AS	B3-90-316	3"(75) 90° Stainless Steel Bend	098268193121	0.86	152.00
820.090.110 AS	B4-90-316	4"(110) 90° Stainless Steel Bend	098268193190	1.48	195.00
820.090.125 S	B5-90-316	5"(125) 90° Stainless Steel Bend	098268193039	3.71	302.00
820.090.160 AS	B6-90-316	6"(160) 90° Stainless Steel Bend	098268193213	4.63	429.50
820.090.200 S	B8-90-316	8"(200) 90° Stainless Steel Bend	098268193053	6.62	1,656.00
820.090.250 S	B10-90-316	10"(250) 90° Stainless Steel Bend	098268213720	10.57	3,821.00

Bends (cont'd) & Tees

45° & 90° Bend Sweeps



Ordering Code	Model	Size/Description	UPC	Wt. (lbs.)	List Price
825.045.200 S	B8-45S-316	8"(200) 45° Stainless Steel Sweep	098268193220	9.22	\$1,304.00
825.045.250 S	B10-45S-316	10"(250) 45° Stainless Steel Sweep	098268193237	14.40	2,366.00
825.045.315 S	B12-45S-316	12"(315) 45° Stainless Steel Sweep	098268193244	23.73	3,442.00
825.090.050 S	B2-90S-316	2"(50) 90° Stainless Steel Sweep	098268193251	1.44	128.00
825.090.075 S	B3-90S-316	3"(75) 90° Stainless Steel Sweep	098268193268	2.21	215.50
825.090.110 S	B4-90S-316	4"(110) 90° Stainless Steel Sweep	098268193275	3.11	287.50
825.090.160 S	B6-90S-316	6"(160) 90° Stainless Steel Sweep	098268193282	6.60	1,098.00
825.090.200 S	B8-90S-316	8"(200) 90° Stainless Steel Sweep	098268193299	14.14	2,039.00
825.090.250 S	B10-90S-316	10"(250) 90° Stainless Steel Sweep	098268193305	21.79	3,821.00
825.090.315 S	B12-90S-316	12"(315) 90° Stainless Steel Sweep	098268216707	34.79	5,019.00

90° Tees



Ordering Code	Model	Size/Description	UPC	Wt. (lbs.)	List Price
830.040.040 S	T1.5x1.5-90-316	1-1/2"(40) x 1-1/2"(40) 90° Stainless Steel Tee	098268193381	0.49	\$126.00
830.040.050 S	T2x1.5-90-316	2"(50) x 1.5"(40) 90° Stainless Steel Tee	098268193398	0.58	126.00
830.050.050 AS	T2x2-90-316	2"(50) x 2"(50) 90° Stainless Steel Tee	098268193411	0.60	126.00
830.050.075 AS	T3x2-90-316	3"(75) x 2"(50) 90° Stainless Steel Tee	098268193435	0.98	148.00
830.050.110 AS	T4x2-90-316	4"(110) x 2"(50) 90° Stainless Steel Tee	098268193459	1.42	179.50
830.075.075 AS	T3x3-90-316	3"(75) x 3"(75) 90° Stainless Steel Tee	098268193466	1.11	148.00
830.075.110 AS	T4x3-90-316	4"(110) x 3"(75) 90° Stainless Steel Tee	098268193633	1.68	179.50
830.075.125 S	T5x3-90-316	5"(125) x 3"(75) 90° Stainless Steel Tee	098268193640	2.07	574.00
830.110.110 AS	T4x4-90-316	4"(110) x 4"(110) 90° Stainless Steel Tee	098268193657	1.95	244.50
830.110.125 S	T5x4-90-316	5"(125) x 4"(110) 90° Stainless Steel Tee	098268193664	2.76	610.50
830.110.160 AS	T6x4-90-316	6"(160) x 4"(110) 90° Stainless Steel Tee	098268193817	4.04	434.50
830.125.125 S	T5x5-90-316	5"(125) x 5"(125) 90° Stainless Steel Tee	098268193862	2.58	574.00
830.160.160 AS	T6x6-90-316	6"(160) x 6"(160) 90° Stainless Steel Tee	098268194043	5.30	574.00
830.160.200 S	T8x6-90-316	8"(200) x 6"(160) 90° Stainless Steel Tee	098268194111	7.61	649.00
830.200.200 S	T8x8-90-316	8"(200) x 8"(200) 90° Stainless Steel Tee	098268194128	9.19	832.50
830.200.250 S	T10x8-90-316	10"(250) x 8"(200) 90° Stainless Steel Tee	098268194135	12.13	1,134.00
830.250.250 S	T10x10-90-316	10"(250) x 10"(250) 90° Stainless Steel Tee	098268194142	14.40	1,351.00
830.250.315 S	T12x10-90-316	12"(315) x 10"(250) 90° Stainless Steel Tee	098268194159	21.94	2,905.00
830.315.315 S	T12x12-90-316	12"(315) x 12"(315) 90° Stainless Steel Tee	098268194166	26.95	3,585.00

90° Threaded Sanitary Straight Tees



Ordering Code	Model	Size/Description	UPC	Wt. (lbs.)	List Price
899-18353-05 S	830.050.050 W 2"NPT	2"(50) x 2"(50) 90° SS NPT Thd Socket Tee	098268207231	1.01	\$1,133.00
899-18353-06 S	830.050.075 W 2"NPT	3"(75) x 2"(50) 90° SS NPT Thd Socket Tee	098268207248	1.39	1,147.00
899-18353-03 S	830.110.110 W 4"NPT	4"(110) x 4"(110) 90° SS NPT Thd Socket Tee	098268207224	2.59	2,618.00
899-18353-02 S	830.110.160 W 4"NPT	6"(160) x 4"(110) 90° SS NPT Thd Socket Tee	098268207200	4.63	2,905.00
899-18353-08 S	830.110.200 W 4"NPT	8"(200) x 4"(110) 90° SS NPT Thd Socket Tee	098268272567	6.81	3,370.00
899-18353-09 S	830.110.250 W 4"NPT	10"(250) x 4"(110) 90° SS NPT Thd Socket Tee	098268272581	9.31	3,693.00
899-18353-01 S	830.110.315 W 4"NPT	12"(315) x 4"(110) 90° SS NPT Thd Socket Tee	098268207194	16.25	3,959.00

Tees

90° Cross Double Tees



Ordering Code	Model	Size/Description	UPC	Wt. (lbs.)	List Price
831.050.050 AS	C2x2-90-316	2" (50) x 2" (50) 90° SS Cross Double Tee	098268194340	0.80	\$573.00
831.050.075 AS	C3x2-90-316	3" (75) x 2" (50) 90° SS Cross Double Tee	098268194357	1.20	573.00
831.050.110 AS	C4x2-90-316	4" (110) x 2" (50) 90° SS Cross Double Tee	098268194364	1.59	573.00
831.075.075 AS	C3x3-90-316	3" (75) x 3" (75) 90° SS Cross Double Tee	098268194371	1.46	573.00
831.075.110 AS	C4x3-90-316	4" (110) x 3" (75) 90° SS Cross Double Tee	098268194524	1.97	573.00
831.110.110 AS	C4x4-90-316	4" (110) x 4" (110) 90° SS Cross Double Tee	098268194579	2.50	667.50
831.110.160 AS	C6x4-90-316	6" (160) x 4" (110) 90° SS Cross Double Tee	098268194616	4.52	832.50
831.160.160 AS	C6x6-90-316	6" (160) x 6" (160) 90° SS Cross Double Tee	098268194623	6.42	1,221.00

90° Offset Double Tees



Ordering Code	Model	Size/Description	UPC	Wt. (lbs.)	List Price
832.050.050 AS	DT2x2-90-316	2" (50) x 2" (50) 90° SS Offset Double Tee	098268194685	0.79	\$602.00
832.050.075 AS	DT3x2-90-316	3" (75) x 2" (50) 90° SS Offset Double Tee	098268194708	1.19	602.00
832.050.110 AS	DT4x2-90-316	4" (110) x 2" (50) 90° SS Offset Double Tee	098268194753	1.59	626.00
832.075.075 AS	DT3x3-90-316	3" (75) x 3" (75) 90° SS Offset Double Tee	098268204766	1.46	602.00
832.075.110 AS	DT4x3-90-316	4" (110) x 3" (75) 90° SS Offset Double Tee	098268204865	1.96	633.00
832.110.110 AS	DT4x4-90-316	4" (110) x 4" (110) 90° SS Offset Double Tee	098268205220	2.49	744.50
832.110.160 AS	DT6x4-90-316	6" (160) x 4" (110) 90° SS Offset Double Tee	098268241952	4.56	889.50
832.160.160 AS	DT6x6-90-316	6" (160) x 6" (160) 90° SS Offset Double Tee	098268205251	6.42	1,033.00

90° Sanitary Sweep Tees



Ordering Code	Model	Size/Description	UPC	Wt. (lbs.)	List Price
848.050.050 AS	SS2x2-90-316	2" (50) x 2" (50) 90° SS Sanitary Sweep Tee	098268207309	0.95	\$432.50
848.050.075 AS	SS3x2-90-316	3" (75) x 2" (50) 90° SS Sanitary Sweep Tee	098268207316	1.30	517.50
848.050.110 AS	SS4x2-90-316	4" (110) x 2" (50) 90° SS Sanitary Sweep Tee	098268207323	1.54	627.00
848.075.075 AS	SS3x3-90-316	3" (75) x 3" (75) 90° SS Sanitary Sweep Tee	098268207347	1.83	611.50
848.075.110 AS	SS4x3-90-316	4" (110) x 3" (75) 90° SS Sanitary Sweep Tee	098268207361	1.87	780.50
848.110.110 AS	SS4x4-90-316	4" (110) x 4" (110) 90° SS Sanitary Sweep Tee	098268207378	3.31	816.50
848.110.160 AS	SS6x4-90-316	6" (160) x 4" (110) 90° SS Sanitary Sweep Tee	098268207385	3.31	840.00
848.160.160 AS	SS6x6-90-316	6" (160) x 6" (160) 90° SS Sanitary Sweep Tee	098268207408	4.45	1,014.00
848.160.250 AS	SS10x6-90-316	10" (250) x 6" (160) 90° SS Sanitary Sweep Tee	098268273403	10.54	2,382.00
848.200.200 AS	SS8x8-90-316	8" (200) x 8" (200) 90° SS Sanitary Sweep Tee	098268273427	10.02	2,854.00
848.200.250 AS	SS10x8-90-316	10" (250) x 8" (200) 90° SS Sanitary Sweep Tee	098268273434	13.05	2,854.00
848.250.250 AS	SS10x10-90-316	10" (250) x 10" (250) 90° SS Sanitary Sweep Tee	098268273458	15.39	3,328.00

90° Threaded Sanitary Sweep Tees



Ordering Code	Model	Size/Description	UPC	Wt. (lbs.)	List Price
899-18353-10 S	848.050.050 W 2" NPT	2" (50) x 2" (50) 90° SS NPT Thd Sanitary Sweep Tee	098268272598	1.08	\$1,546.00
899-18353-11 S	848.075.075 W 3" NPT	3" (75) x 3" (75) 90° SS NPT Thd Sanitary Sweep Tee	098268272642	2.18	1,869.00
899-18353-12 S	848.110.110 W 4" NPT	4" (110) x 4" (110) 90° SS NPT Thd Sanitary Sweep Tee	098268272659	2.84	2,923.00

Wyes

45° Wyes



Ordering Code	Model	Size/Description	UPC	Wt. (lbs.)	List Price
838.040.040 S	W1.5x1.5-45-316	1-1/2"(40) x 1-1/2"(40) 45° Stainless Steel Wye	098268204124	0.55	\$201.50
838.040.050 S	W2x1.5-45-316	2"(50) x 1-1/2"(40) 45° Stainless Steel Wye	098268222524	0.66	208.50
838.050.050 S	W2x2-45-316	2"(50) x 2"(50) 45° Stainless Steel Wye	098268222531	0.71	216.00
838.050.075 S	W3x2-45-316	3"(75) x 2"(50) 45° Stainless Steel Wye	098268222548	1.06	224.00
838.050.110 S	W4x2-45-316	4"(110) x 2"(50) 45° Stainless Steel Wye	098268222555	1.54	273.00
838.050.160 S	W6x2-45-316	6"(160) x 2"(50) 45° Stainless Steel Wye	098268230451	2.14	818.00
838.050.200 S	W8x2-45-316	8"(200) x 2"(50) 45° Stainless Steel Wye	098268229752	6.09	1,189.00
838.075.075 S	W3x3-45-316	3"(75) x 3"(75) 45° Stainless Steel Wye	098268222579	1.41	213.50
838.075.110 S	W4x3-45-316	4"(110) x 3"(75) 45° Stainless Steel Wye	098268222586	1.94	245.00
838.110.110 S	W4x4-45-316	4"(110) x 4"(110) 45° Stainless Steel Wye	098268203738	2.56	338.00
838.110.125 S	W5x4-45-316	5"(125) x 4"(110) 45° Stainless Steel Wye	098268222616	3.31	409.00
838.110.160 S	W6x4-45-316	6"(160) x 4"(110) 45° Stainless Steel Wye	098268222630	4.66	589.50
838.110.200 S	W8x4-45-316	8"(200) x 4"(110) 45° Stainless Steel Wye	098268230475	7.15	1,189.00
838.110.250 S	W10x4-45-316	10"(250) x 4"(110) 45° Stainless Steel Wye	098268230482	9.92	2,115.00
838.110.315 S	W12x4-45-316	12"(315) x 4"(110) 45° Stainless Steel Wye	098268230499	16.73	3,040.00
838.125.125 S	W5x5-45-316	5"(125) x 5"(125) 45° Stainless Steel Wye	098268230512	3.70	531.00
838.160.160 S	W6x6-45-316	6"(160) x 6"(160) 45° Stainless Steel Wye	098268223392	6.71	625.00
838.160.200 S	W8x6-45-316	8"(200) x 6"(160) 45° Stainless Steel Wye	098268223415	9.63	1,189.00
838.160.250 S	W10x6-45-316	10"(250) x 6"(160) 45° Stainless Steel Wye	098268230529	12.40	2,265.00
838.160.315 S	W12x6-45-316	12"(315) x 6"(160) 45° Stainless Steel Wye	098268230543	20.22	4,589.00
838.200.200 S	W8x8-45-316	8"(200) x 8"(200) 45° Stainless Steel Wye	098268223446	12.06	1,292.00
838.200.250 S	W10x8-45-316	10"(250) x 8"(200) 45° Stainless Steel Wye	098268223484	14.57	2,238.00
838.200.315 S	W12x8-45-316	12"(315) x 8"(200) 45° Stainless Steel Wye	098268230550	24.03	3,623.00
838.250.250 S	W10x10-45-316	10"(250) x 10"(250) 45° Stainless Steel Wye	098268223491	18.89	1,862.00
838.250.315 S	W12x10-45-316	12"(315) x 10"(250) 45° Stainless Steel Wye	098268223507	27.52	2,896.00
838.315.315 S	W12x12-45-316	12"(315) x 12"(315) 45° Stainless Steel Wye	098268223514	36.45	4,656.00

45° Combination Wyes 1/8 Bends



Ordering Code	Model	Size/Description	UPC	Wt. (lbs.)	List Price
839.050.050 AS	WB-2x2-90-316	2"(50) x 2"(50) 45° Stainless Steel Combo Wye	098268229639	0.97	\$337.00
839.050.075 AS	WB-3x2-90-316	3"(75) x 2"(50) 45° Stainless Steel Combo Wye	098268230567	1.65	349.50
839.050.110 AS	WB-4x2-90-316	4"(110) x 2"(50) 45° Stainless Steel Combo Wye	098268229691	1.79	408.50
839.075.075 AS	WB-3x3-90-316	3"(75) x 3"(75) 45° Stainless Steel Combo Wye	098268229653	1.92	495.50
839.075.110 AS	WB-4x3-90-316	4"(110) x 3"(75) 45° Stainless Steel Combo Wye	098268229806	2.45	524.50
839.075.160 AS	WB-6x3-90-316	6"(160) x 3"(75) 45° Stainless Steel Combo Wye	098268272673	2.20	733.50
839.110.110 AS	WB-4x4-90-316	4"(110) x 4"(110) 45° Stainless Steel Combo Wye	098268229646	3.62	560.50
839.110.160 AS	WB-6x4-90-316	6"(160) x 4"(110) 45° Stainless Steel Combo Wye	098268229660	5.58	733.50
839.110.200 AS	WB-8x4-90-316	8"(200) x 4"(110) 45° Stainless Steel Combo Wye	098268230574	8.11	1,816.00
839.160.160 AS	WB-6x6-90-316	6"(160) x 6"(160) 45° Stainless Steel Combo Wye	098268229677	9.96	931.50
839.160.200 AS	WB-8x6-90-316	8"(200) x 6"(160) 45° Stainless Steel Combo Wye	098268272680	10.25	1,816.00
839.160.250 AS	WB-10x6-90-316	10"(250) x 6"(160) 45° Stainless Steel Combo Wye	098268272697	13.32	2,398.00
839.160.315 AS	WB-12x6-90-316	12"(315) x 6"(160) 45° Stainless Steel Combo Wye	098268274202	21.09	4,020.00
839.200.200 S	WB-8x8-90-316	8"(200) x 8"(200) 45° Stainless Steel Combo Wye	098268223606	13.52	2,008.00
839.250.250 S	WB-10x10-90-316	10"(250) x 10"(250) 45° Stainless Steel Combo Wye	098268213737	21.32	2,398.00
839.315.315 S	WB-12x12-90-316	12"(315) x 12"(315) 45° Stainless Steel Combo Wye	098268272703	48.22	9,785.00

Wyes

45° Double Wyes



Ordering Code	Model	Size/Description	UPC	Wt. (lbs.)	List Price
836.050.050 S	DW2x2-45-316	2"(50) x 2"(50) 45° Stainless Steel Double Wye	098268221480	1.30	\$429.50
836.050.075 S	DW3x2-45-316	3"(75) x 2"(50) 45° Stainless Steel Double Wye	098268222166	1.52	472.50
836.050.110 S	DW4x2-45-316	4"(110) X 2"(50) 45° degree Stainless Steel Double Wye	098268222197	1.76	585.00
836.075.075 S	DW3x3-45-316	3"(75) x 3"(75) 45° Stainless Steel Double Wye	098268222319	2.54	625.00
836.075.110 S	DW4x3-45-316	4"(110) x 3"(75) 45° Stainless Steel Double Wye	098268222326	2.89	638.50
836.110.110 S	DW4x4-45-316	4"(110) x 4"(110) 45° Stainless Steel Double Wye	098268222371	4.63	649.00
836.110.125 S	DW5x4-45-316	5"(125) x 4"(110) 45° Stainless Steel Double Wye	098268213744	3.64	720.50
836.110.160 S	DW6x4-45-316	6"(160) x 4"(110) 45° Stainless Steel Double Wye	098268222388	6.28	860.50
836.125.125 S	DW5x5-45-316	5"(125) x 5"(125) 45° Stainless Steel Double Wye	098268213751	4.63	1,050.00
836.160.160 S	DW6x6-45-316	6"(160) x 6"(160) 45° Stainless Steel Double Wye	098268222395	11.64	1,292.00
836.200.200 S	DW8x8-45-316	8"(200) x 8"(200) 45° Stainless Steel Double Wye	098268222425	11.64	1,650.00
836.250.250 S	DW10x10-45-316	10"(250) x 10"(250) 45° Stainless Steel Double Wye	098268222432	15.45	2,009.00

45° Double Wyes - 90° Offset



Ordering Code	Model	Size/Description	UPC	Wt. (lbs.)	List Price
837.050.050 S	OW2x2-45-316	2"(50) x 2"(50) 45° Stainless Steel Double Wye - 90° Offset	098268222449	1.08	\$466.00
837.050.075 S	OW3x2-45-316	3"(75) x 2"(50) 45° Stainless Steel Double Wye - 90° Offset	098268222456	1.48	700.50
837.050.110 S	OW4x2-45-316	4"(110) x 2"(50) 45° Stainless Steel Double Wye - 90° Offset	098268222463	2.03	853.50
837.075.075 S	OW3x3-45-316	3"(75) x 3"(75) 45° Stainless Steel Double Wye - 90° Offset	098268222470	3.15	700.50
837.075.110 S	OW4x3-45-316	4"(110) x 3"(75) 45° Stainless Steel Double Wye - 90° Offset	098268222487	2.89	840.00
837.110.110 S	OW4x4-45-316	4"(110) x 4"(110) 45° Stainless Steel Double Wye - 90° Offset	098268222494	4.56	1,004.00
837.110.160 S	OW6x4-45-316	6"(160) x 4"(110) 45° Stainless Steel Double Wye - 90° Offset	098268222500	4.56	1,041.00
837.160.160 S	OW6x6-45-316	6"(160) x 6"(160) 45° Stainless Steel Double Wye - 90° Offset	098268222517	8.86	1,077.00

Access Pipe

Straight Access Pipe



Ordering Code	Model	Size/Description	UPC	Wt. (lbs.)	List Price
840.075.075 S	AP-3-316	3"(75) Stainless Steel Straight Access Pipe	098268223651	1.41	\$251.50
840.110.110 S	AP-4-316	4"(110) Stainless Steel Straight Access Pipe	098268202663	1.98	359.50
840.125.125 S	AP-5-316	5"(125) Stainless Steel Straight Access Pipe	098268223668	2.83	660.00
840.160.160 S	AP-6-316	6"(160) Stainless Steel Straight Access Pipe	098268223675	5.31	684.50
840.200.200 S	AP-8-316	8"(200) Stainless Steel Straight Access Pipe	098268223699	7.61	884.50

90° Access Tees



Ordering Code	Model	Size/Description	UPC	Wt. (lbs.)	List Price
834.110.110 S	AT-4x4-316	4"(110) x 4"(110) 90° Stainless Steel Access Tee	098268221398	2.58	\$602.00
834.160.160 S	AT-6x6-316	6"(160) x 6"(160) 90° Stainless Steel Access Tee	098268221473	5.11	748.50

90° Access Bends



Ordering Code	Model	Size/Description	UPC	Wt. (lbs.)	List Price
822.090.075 S	AB-3-316	3"(75) 90° Stainless Steel Access Bend	098268206975	1.35	\$493.00
822.090.110 S	AB-4-316	4"(110) 90° Stainless Steel Access Bend	098268200966	2.12	675.00
822.090.160 S	AB-6-316	6"(160) 90° Stainless Steel Access Bend	098268206982	4.34	952.00

Increasesers



Eccentric Increasesers

Ordering Code	Model	Size/Description	UPC	Wt. (lbs.)	List Price
850.040.050 S	EI-2x1-1/2-316	2"(50) x 1-1/2"(40) Stainless Steel Eccentric Increaser	098268216424	0.35	\$143.00
850.050.075 S	EI-3x2-316	3"(75) x 2"(50) Stainless Steel Eccentric Increaser	098268226270	0.49	143.00
850.050.110 S	EI-4x2-316	4"(110) x 2"(50) Stainless Steel Eccentric Increaser	098268203356	0.84	151.50
850.075.110 S	EI-4x3-316	4"(110) x 3"(75) Stainless Steel Eccentric Increaser	098268226522	0.93	172.00
850.110.125 S	EI-5x4-316	5"(125) x 4"(110) Stainless Steel Eccentric Increaser	098268218459	1.09	286.00
850.075.160 S	EI-6x3-316	6"(160) x 3"(75) Stainless Steel Eccentric Increaser	098268226560	1.95	308.00
850.110.160 S	EI-6x4-316	6"(160) x 4"(110) Stainless Steel Eccentric Increaser	098268226645	1.91	344.00
850.125.160 S	EI-6x5-316	6"(160) x 5"(125) Stainless Steel Eccentric Increaser	098268226683	2.11	460.00
850.160.200 S	EI-8x6-316	8"(200) x 6"(160) Stainless Steel Eccentric Increaser	098268226812	3.68	573.00
850.200.250 S	EI-10x8-316	10"(250) x 8"(200) Stainless Steel Eccentric Increaser	098268227084	5.67	632.00
850.200.315 S	EI-12x8-316	12"(315) x 8"(200) Stainless Steel Eccentric Increaser	098268227062	10.17	1,380.00
850.250.315 S	EI-12x10-316	12"(315) x 10"(250) Stainless Steel Eccentric Increaser	098268227130	10.63	1,452.00

Concentric Increasesers



Ordering Code	Model	Size/Description	UPC	Wt. (lbs.)	List Price
850.040.050 CS	CI-2x1-1/2-316	2"(50) x 1-1/2"(40) Stainless Steel Concentric Increaser	098268216424	0.36	\$151.50
850.050.075 CS	CI-3x2-316	3"(75) x 2"(50) Stainless Steel Concentric Increaser	098268226294	0.44	151.50
850.050.110 CS	CI-4x2-316	4"(110) x 2"(50) Stainless Steel Concentric Increaser	098268226485	0.66	171.00
850.075.110 CS	CI-4x3-316	4"(110) x 3"(75) Stainless Steel Concentric Increaser	098268195064	0.82	171.00
850.110.125 CS	CI-5x4-316	5"(125) x 4"(110) Stainless Steel Concentric Increaser	098268226638	1.09	230.50
850.110.160 CS	CI-6x4-316	6"(160) x 4"(110) Stainless Steel Concentric Increaser	098268230673	2.21	230.50
850.110.200 CS	CI-8x4-316	8"(200) x 4"(110) Stainless Steel Concentric Increaser	098268230680	2.86	538.50
850.110.250 CS	CI-10x4-316	10"(250) x 4"(110) Stainless Steel Concentric Increaser	098268230703	4.08	968.50
850.125.160 CS	CI-6x5-316	6"(160) x 5"(125) Stainless Steel Concentric Increaser	098268226683	2.11	335.00
850.160.200 CS	CI-8x6-316	8"(200) x 6"(160) Stainless Steel Concentric Increaser	098268226829	3.31	538.50
850.160.250 CS	CI-10x6-316	10"(250) x 6"(160) Stainless Steel Concentric Increaser	098268230710	4.52	968.50
850.200.250 CS	CI-10x8-316	10"(250) x 8"(200) Stainless Steel Concentric Increaser	098268227055	4.37	968.50
850.200.315 CS	CI-12x8-316	12"(315) x 8"(200) Stainless Steel Concentric Increaser	098268227062	10.17	1,318.00
850.250.315 CS	CI-12x10-316	12"(315) x 10"(250) Stainless Steel Concentric Increaser	098268227130	10.63	1,573.00

Reducers



Eccentric Reducers

Ordering Code	Model	Size/Description	UPC	Wt. (lbs.)	List Price
850.075.050 S	ER-2x3-316	2"(50) x 3"(75) Stainless Steel Eccentric Reducer	098268226515	0.62	\$180.00
850.110.050 S	ER-2x4-316	2"(50) x 4"(110) Stainless Steel Eccentric Reducer	098268203400	1.10	216.00
850.110.075 S	ER-3x4-316	3"(75) x 4"(110) Stainless Steel Eccentric Reducer	098268203417	1.22	243.50
850.160.110 S	ER-4x6-316	4"(110) x 6"(160) Stainless Steel Eccentric Reducer	098268226782	2.38	280.50
850.200.160 S	ER-6x8-316	6"(160) x 8"(200) Stainless Steel Eccentric Reducer	098268227031	3.90	595.50
850.250.200 S	ER-8x10-316	8"(200) x 10"(250) Stainless Steel Eccentric Reducer	098268227123	5.98	792.50
850.315.250 S	ER-10x12-316	10"(250) x 12"(315) Stainless Steel Eccentric Reducer	098268227154	10.87	1,436.00

Double Couplings



Double Couplings

Ordering Code	Model	Size/Description	UPC	Wt. (lbs.)	List Price
841.040.040 S	DC-1.5-316	1-1/2"(40) Stainless Steel Double Coupling	098268224566	0.29	\$60.00
841.050.050 S	DC-2-316	2"(50) Stainless Steel Double Coupling	098268213089	0.33	63.75
841.075.075 S	DC-3-316	3"(75) Stainless Steel Double Coupling	098268224573	0.57	70.50
841.110.110 S	DC-4-316	4"(110) Stainless Steel Double Coupling	098268204285	0.99	85.25
841.125.125 S	DC-5-316	5"(125) Stainless Steel Double Coupling	098268224597	1.19	116.50
841.160.160 S	DC-6-316	6"(160) Stainless Steel Double Coupling	098268224610	2.32	196.50
841.200.200 S	DC-8-316	8"(200) Stainless Steel Double Coupling	098268224641	4.08	323.50
841.250.250 S	DC-10-316	10"(250) Stainless Steel Double Coupling	098268224658	6.86	422.50
841.315.315 S	DC-12-316	12"(315) Stainless Steel Double Coupling	098268224672	11.82	962.00

Double Slip Couplings



Ordering Code	Model	Size/Description	UPC	Wt. (lbs.)	List Price
842.040.040 S	DSC-1.5-316	1-1/2"(40) Stainless Steel Double Slip Coupling	098268224726	0.29	\$65.25
842.050.050 S	DSC-2-316	2"(50) Stainless Steel Double Slip Coupling	098268224757	0.27	66.50
842.075.075 S	DSC-3-316	3"(75) Stainless Steel Double Slip Coupling	098268224771	0.46	69.50
842.110.110 S	DSC-4-316	4"(110) Stainless Steel Double Slip Coupling	098268222562	0.99	81.75
842.125.125 S	DSC-5-316	5"(125) Stainless Steel Double Slip Coupling	098268222593	1.04	141.00
842.160.160 S	DSC-6-316	6"(160) Stainless Steel Double Slip Coupling	098268202922	2.32	195.00
842.200.200 S	DSC-8-316	8"(200) Stainless Steel Double Slip Coupling	098268222623	4.01	255.50
842.250.250 S	DSC-10-316	10"(250) Stainless Steel Double Slip Coupling	098268222692	6.86	432.50
842.315.315 S	DSC-12-316	12"(315) Stainless Steel Double Slip Coupling	098268222906	11.82	1,009.00

Expansion Sockets



Expansion Sockets

Ordering Code	Model	Size/Description	UPC	Wt. (lbs.)	List Price
843.095.040 S	ES-1.5-316	1-1/2"(40) Stainless Steel Expansion Socket	098268222968	0.38	\$70.25
843.105.050 S	ES-2-316	2"(50) Stainless Steel Expansion Socket	098268222975	0.46	74.50
843.115.075 S	ES-3-316	3"(75) Stainless Steel Expansion Socket	098268222982	0.79	84.75
843.125.110 S	ES-4-316	4"(110) Stainless Steel Expansion Socket	098268223200	1.26	98.00
843.140.125 S	ES-5-316	5"(125) Stainless Steel Expansion Socket	098268223293	1.79	229.00
843.182.160 S	ES-6-316	6"(160) Stainless Steel Expansion Socket	098268223309	3.42	300.50

Long Expansion Sockets



Ordering Code	Model	Size/Description	UPC	Wt. (lbs.)	List Price
869.143.050 S	LES-2-316	2"(50) Stainless Steel Long Expansion Socket	098268228311	0.55	\$187.50
869.163.075 S	LES-3-316	3"(75) Stainless Steel Long Expansion Socket	098268228342	0.88	239.00
869.181.110 S	LES-4-316	4"(110) Stainless Steel Long Expansion Socket	098268228366	1.54	281.00
869.200.125 S	LES-5-316	5"(125) Stainless Steel Long Expansion Socket	098268228519	2.18	554.50
869.238.160 S	LES-6-316	6"(160) Stainless Steel Long Expansion Socket	098268228526	4.08	780.00
869.300.200 S	LES-8-316	8"(200) Stainless Steel Long Expansion Socket	098268228533	5.36	1,040.00

Adapters

Female Adapters



Ordering Code	Model	Size/Description	UPC	Wt. (lbs.)	List Price
885.032.040 S	FA-1-1/2x1-1/4-316	1-1/2"(40) x 1-1/4"(32) Stainless Steel Female Adapter	098268228731	0.44	\$144.00
885.040.040 S	FA-1-1/2x1-1/2-316	1-1/2"(40) x 1-1/2"(40) Stainless Steel Female Adapter	098268228847	0.44	144.00
885.025.050 S	FA-2x1-316	2"(50) x 1"(25) Stainless Steel Female Adapter	098268200317	0.40	111.50
885.032.050 S	FA-2x1-1/4-316	2"(50) x 1-1/4"(32) Stainless Steel Female Adapter	098268228748	0.38	121.00
885.040.050 S	FA-2x1-1/2-316	2"(50) x 1-1/2"(40) Stainless Steel Female Adapter	098268228922	0.42	156.50
885.050.050 S	FA-2x2-316	2"(50) x 2"(50) Stainless Steel Female Adapter	098268203653	0.49	158.50

Male Adapters



Ordering Code	Model	Size/Description	UPC	Wt. (lbs.)	List Price
886.050.032 S	MA-1-1/4x2-316	1-1/4"(32) x 2"(50) Stainless Steel Male Adapter	098268228939	0.55	\$92.25
886.050.040 S	MA-1-1/2x2-316	1-1/2"(40) x 2"(50) Stainless Steel Male Adapter	098268228946	0.51	98.00
886.050.050 S	MA-2x2-316	2"(50) x 2"(50) Stainless Steel Male Adapter	098268228953	0.60	108.50

Female Adapters with Socket



Ordering Code	Model	Size/Description	UPC	Wt. (lbs.)	List Price
886.175.075 S	FA-3x3-316	3"(75) x 3"(75) Stainless Steel Female Adapter w/Socket	098268230826	1.41	\$640.00
886.1110.110 S	FA-4x4-316	4"(110) x 4"(110) Stainless Steel Female Adapter w/Socket	098268230819	1.72	1,221.00

Side Inlet Adapters



Ordering Code	Model	Size/Description	UPC	Wt. (lbs.)	List Price
850.050.032 S	CSIA-1-1/4x2-316	1-1/4"(32) x 2"(50) Stainless Steel Side Inlet Adapter	098268226256	0.33	\$110.00
850.050.040 S	ESIA-1-1/2x2-316	1-1/2"(40) x 2"(50) Stainless Steel Side Inlet Adapter	098268226263	0.22	140.00

Sealing Rings



EPDM Sealing Rings - Black/Standard Applications

Ordering Code	Model	Size/Description	UPC	Wt. (lbs.)	List Price
801.EPDM.032	EPDM-1.25	1-1/4" Black EPDM Sealing Ring-Standard Applications	098268175110	0.02	\$9.75
801.EPDM.040	EPDM-1.5	1-1/2" Black EPDM Sealing Ring-Standard Applications	098268175264	0.02	9.75
801.EPDM.050	EPDM-2	2" Black EPDM Sealing Ring-Standard Applications	098268175271	0.02	11.50
801.EPDM.075	EPDM-3	3" Black EPDM Sealing Ring-Standard Applications	098268175288	0.02	11.50
801.EPDM.110	EPDM-4	4" Black EPDM Sealing Ring-Standard Applications	098268175349	0.04	13.00
801.EPDM.125	EPDM-5	5" Black EPDM Sealing Ring-Standard Applications	098268182828	0.07	14.75
801.EPDM.160	EPDM-6	6" Black EPDM Sealing Ring-Standard Applications	098268175387	0.11	17.25
801.EPDM.200	EPDM-8	8" Black EPDM Sealing Ring-Standard Applications	098268175431	0.15	19.25
801.EPDM.250	EPDM-10	10" Black EPDM Sealing Ring-Standard Applications	098268175493	0.37	21.00
801.EPDM.315	EPDM-12	12" Black EPDM Sealing Ring-Standard Applications	098268216677	0.57	30.75



FPM Sealing Rings - Green/High Temperature Applications

Ordering Code	Model	Size/Description	UPC	Wt. (lbs.)	List Price
801.FPM.040	FPM-1.5	1-1/2" Green FPM Sealing Ring-High Temp Applications	098268175516	0.02	\$32.00
801.FPM.050	FPM-2	2" Green FPM Sealing Ring-High Temp Applications	098268175547	0.02	32.00
801.FPM.075	FPM-3	3" Green FPM Sealing Ring-High Temp Applications	098268175646	0.02	40.75
801.FPM.110	FPM-4	4" Green FPM Sealing Ring-High Temp Applications	098268175783	0.04	79.75
801.FPM.125	FPM-5	5" Green FPM Sealing Ring-High Temp Applications	098268182835	0.07	139.00
801.FPM.160	FPM-6	6" Green FPM Sealing Ring-High Temp Applications	098268175790	0.11	166.00
801.FPM.200	FPM-8	8" Green FPM Sealing Ring-High Temp Applications	098268175806	0.15	235.00
801.FPM.250	FPM-10	10" Green FPM Sealing Ring-High Temp Applications	098268175820	0.37	699.00
801.FPM.315	FPM-12	12" Green FPM Sealing Ring-High Temp Applications	098268182873	0.57	811.00



NBR Sealing Rings - Yellow Dot/Petroleum Applications

Ordering Code	Model	Size/Description	UPC	Wt. (lbs.)	List Price
801.NBR.050	NBR-2	2" Yellow Dot NBR Sealing Ring-Petroleum Apps.	098268175851	0.02	13.50
801.NBR.075	NBR-3	3" Yellow Dot NBR Sealing Ring-Petroleum Apps.	098268175882	0.02	13.50
801.NBR.110	NBR-4	4" Yellow Dot NBR Sealing Ring-Petroleum Apps.	098268176025	0.04	14.75
801.NBR.125	NBR-5	5" Yellow Dot NBR Sealing Ring-Petroleum Apps.	098268182880	0.07	14.75
801.NBR.160	NBR-6	6" Yellow Dot NBR Sealing Ring-Petroleum Apps.	098268176087	0.11	17.25
801.NBR.200	NBR-8	8" Yellow Dot NBR Sealing Ring-Petroleum Apps.	098268176117	0.15	25.75
801.NBR.250	NBR-10	10" Yellow Dot NBR Sealing Ring-Petroleum Apps.	098268176124	0.38	54.00

Transition Couplings



Ordering Code	Model	Size/Description	UPC	Wt. (lbs.)	List Price
8187919	BTC-2x2	2" x 2" BTC Transition Coupling	098268192933	0.26	\$50.00
8187921	BTC-3x3-NH	3" x 3" No Hub BTC Transition Coupling	098268192940	0.31	79.75
8187920	BTC-3x3-SCH40	3" x 3" Schedule 40 BTC Transition Coupling	098268192957	0.33	79.75
8187923	BTC-4x4-NH	4" x 4" No Hub BTC Transition Coupling	098268192964	0.40	79.75
8187922	BTC-4x4-SCH40	4" x 4" Schedule 40 BTC Transition Coupling	098268192971	0.44	79.75
8187925	BTC-6x6-NH	6" x 6" No Hub BTC Transition Coupling	098268192988	0.50	159.50
8187924	BTC-6x6-SCH40	6" x 6" Schedule 40 BTC Transition Coupling	098268192995	0.50	159.50

Traps



P-Traps

Ordering Code	Model	Size/Description	UPC	Wt. (lbs.)	List Price
525.090.050 S	PT-2	2"(50) Stainless Steel P-Trap	098268229288	0.99	\$410.50
525.090.075 S	PT-3	3"(75) Stainless Steel P-Trap	098268229271	1.85	488.00
525.090.110 S	PT-4	4"(110) Stainless Steel P-Trap	098268229264	3.28	582.00
525.090.125 S	PT-5	5"(125) Stainless Steel P-Trap	098268229257	4.41	853.50
525.090.160 S	PT-6	6"(160) Stainless Steel P-Trap	098268229028	13.71	921.50



P-Traps with 1/2" Trap Primer Tapping

Ordering Code	Model	Size/Description	UPC	Wt. (lbs.)	List Price
525.090.050.97 S	PT-2-TPT	2"(50) Stainless Steel P-Trap w/Trap Primer Tapping	098268236071	0.99	\$741.50
525.090.075.97 S	PT-3-TPT	3"(75) Stainless Steel P-Trap w/Trap Primer Tapping	098268246001	1.95	827.00
525.090.110.97 S	PT-4-TPT	4"(110) Stainless Steel P-Trap w/Trap Primer Tapping	098268233636	3.50	930.00



P-Traps with Coupling & Drain Plug

Ordering Code	Model	Size/Description	UPC	Wt. (lbs.)	List Price
525.032.050 S	PTC-2x1-1/4-316	2"(50) x 1-1/4"(32) SS P-Trap w/Coupling & Drain Plug	098268229318	2.09	\$845.50
525.040.050 S	PTC-2x1-1/2-316	2"(50) x 1-1/2"(40) SS P-Trap w/Coupling & Drain Plug	098268229301	1.98	845.50
525.050.050 S	PTC-2x2-316	2"(50) x 2"(50) SS P-Trap w/Coupling & Drain Plug	098268229295	1.94	845.50

PT-L Traps



Ordering Code	Model	Size/Description	UPC	Wt. (lbs.)	List Price
599-14979-03 S	PT-2L	2"(50) Stainless Steel PT-L Trap	098268236156	2.19	\$480.00
599-14979-04 S	PT-3L	3"(75) Stainless Steel PT-L Trap	098268236163	4.17	985.00
599-14979-05 S	PT-4L	4"(110) Stainless Steel PT-L Trap	098268236323	9.72	1,780.00
599-14979-06 S	PT-6L	6"(160) Stainless Steel PT-L Trap	098268236378	21.84	3,005.00
599-14979-02 S	PT-8L	8"(200) Stainless Steel PT-L Trap	098268236149	34.39	4,725.00
599-14979-07 S	PT-10L	10"(250) Stainless Steel PT-L Trap	098268236385	53.69	5,670.00
599-18972-04 S	PT-12L	12"(315) Stainless Steel PT-L Trap	098268281675	72.59	12,450.00

PT-XL Traps



Ordering Code	Model	Size/Description	UPC	Wt. (lbs.)	List Price
599-9000212-02 S	PT-3XL	3"(75) Stainless Steel PT-XL Trap	098268353723	14.46	\$2,762.00
599-9000212-01 S	PT-4XL	4"(110) Stainless Steel PT-XL Trap	098268353778	26.70	3,775.00
599-9000212-03 S	PT-6XL	6"(160) Stainless Steel PT-XL Trap	098268353877	68.54	6,475.00

Removable Two-Part Water Traps



Ordering Code	Model	Size/Description	UPC	Wt. (lbs.)	List Price
502.050.110 MS	BWT-1T	4"(108) SS Removable Two-Part Water Trap	098268229363	0.79	\$233.50
562.102.000 S	BWT-2T	6"(157) SS Removable Two-Part Water Trap	098268215786	1.76	350.50
562.103.000 S	BWT-3T	10"(246) SS Removable Two-Part Water Trap	098268246018	4.85	460.00

Bottle Traps



Ordering Code	Model	Size/Description	UPC	Wt. (lbs.)	List Price
505.032.050 S	BT-1-1/4	1-1/4"(32) Stainless Steel Bottle Trap	098268229349	2.09	\$763.00
505.040.050 S	BT-1-1/2	1-1/2"(40) Stainless Steel Bottle Trap	098268229332	1.87	763.00
505.050.050 S	BT-2	2"(50) Stainless Steel Bottle Trap	098268229325	2.65	763.00

Tailpiece Adapters



Ordering Code	Model	Size/Description	UPC	Wt. (lbs.)	List Price
851.025.040 S	TA-1-1/2x2-316	1-1/2"(40) x 2"(50) Stainless Steel Tail Piece Adapter	098268227161	0.77	\$350.50

Dual Containment

Dual Containment Spacers

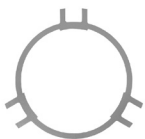

Ordering Code	Model	Size/Description	UPC	Wt. (lbs.)	List Price
899-10751-04 S	BDCS-2x4-316	2"(50) x 4"(110) Stainless Steel Dual Containment Spacer	098268280821	0.05	\$95.25
899-10751-06 S	BDCS-3x4-316	3"(75) x 4"(110) Stainless Steel Dual Containment Spacer	098268280838	0.09	95.25
899-10751-03 S	BDCS-4x6-316	4"(110) x 6"(160) Stainless Steel Dual Containment Spacer	098268280845	0.05	95.25
899-10751-05 S	BDCS-6x8-316	6"(160) x 8"(200) Stainless Steel Dual Containment Spacer	098268280883	0.15	125.50
899-10751-07 S	BDCS-6x12-316	6"(160) x 12"(315) Stainless Steel Dual Containment Spacer	098268280906	0.63	256.00

Adapters

DIN Universal Flange Adapter with Socket - PN16 DIN 2633/EN1092-1



Ordering Code	Model	Size/Description	UPC	Wt. (lbs.)	List Price
854.500.050 S	854.500.050 S	2"(50) x 3"(75) SS DIN Universal Flange Adapter w/Socket	098268227642	1.87	\$359.50
854.500.075 S	854.500.075 S	3"(75) x 3"(75) SS DIN Universal Flange Adapter w/Socket	098268227659	3.28	502.50
854.500.110 S	854.500.110 S	4"(110) x 3"(75) SS DIN Universal Flange Adapter w/Socket	098268216745	4.76	610.50
854.500.160 S	854.500.160 S	6"(160) x 3"(75) SS DIN Universal Flange Adapter w/Socket	098268216752	8.20	860.50

ANSI Spigot Flange Adapter - ANSI B16.5



Ordering Code	Model	Size/Description	UPC	Wt. (lbs.)	List Price
854.035.040 S	854.035.040 S	1-1/2"(40) x 6"(152) SS ANSI Spigot Flange Adapter	098268227321	5.64	\$878.50
854.035.050 S	854.035.050 S	2"(50) x 6"(152) SS ANSI Spigot Flange Adapter	098268227369	5.27	949.00
854.035.075 S	854.035.075 S	3"(75) x 7-1/2"(191) SS ANSI Spigot Flange Adapter	098268227376	9.96	1,242.00
854.035.110 S	854.035.110 S	4"(110) x 9"(229) SS ANSI Spigot Flange Adapter	098268227383	12.90	1,808.00

Welding Sleeves

Socket Deck Penetration with Welding Sleeve



Ordering Code	Model	Size/Description	UPC	Wt. (lbs.)	List Price
870.000.040FS	870.000.040FS	1-1/2"(40) SS Socket Deck Penetration w/Welding Sleeve & Spigot	098268216851	3.20	\$520.50
870.000.050FS	870.000.050FS	2"(50) SS Socket Deck Penetration w/Welding Sleeve & Spigot	098268218923	3.24	520.50
870.000.075FS	870.000.075FS	3"(75) SS Socket Deck Penetration w/Welding Sleeve & Spigot	098268218930	3.84	619.50
870.000.110FS	870.000.110FS	4"(110) SS Socket Deck Penetration w/Welding Sleeve & Spigot	098268218978	5.05	710.00

Deck Penetration with Welding Sleeve



Ordering Code	Model	Size/Description	UPC	Wt. (lbs.)	List Price
872.050.040 S	872.050.040 S	1-1/2"(40) SS Deck Penetration w/Welding Sleeve & Spigot	098268228540	1.83	\$370.50
872.060.050 S	872.060.050 S	2"(50) SS Deck Penetration w/Welding Sleeve & Spigot	098268228557	1.81	370.50
872.076.075 S	872.076.075 S	3"(75) SS Deck Penetration w/Welding Sleeve - 3" OD & Spigot	098268228564	2.18	405.00
872.089.075 S	872.089.075 S	3"(75) SS Deck Penetration w/Welding Sleeve - 3-1/2" OD & Spigot	098268228571	2.76	405.00
872.114.110 S	872.114.110 S	4"(110) SS Deck Penetration w/Welding Sleeve & Spigot	098268228588	3.90	460.00
872.150.125 S	872.150.125 S	5"(125) SS Deck Penetration w/Welding Sleeve & Spigot	098268277111	4.57	713.50
872.168.160 S	872.168.160 S	6"(160) SS Deck Penetration w/Welding Sleeve & Spigot	098268277128	3.95	522.50
872.210.200 S	872.210.200 S	8"(200) SS Deck Penetration w/Welding Sleeve & Spigot	098268277142	7.42	782.50

Welding Sleeves

Deck Penetration with Welding Sleeve

Ordering Code	Model	Size/Description	UPC	Wt. (lbs.)	List Price
875.050.040 S	875.050.040 S	1-1/2"(40) SS Deck Penetration w/Welding Sleeve & Socket - EPDM	098268276800	1.37	\$424.00
875.060.050 S	875.060.050 S	2"(50) SS Deck Penetration w/Welding Sleeve & Socket - EPDM	098268276831	1.83	269.00
875.076.075 S	875.076.075 S	3"(75) SS Deck Penetration w/Welding Sleeve & Socket - EPDM 3" OD	098268276855	2.24	385.50
875.089.075 S	875.089.075 S	3"(75) SS Deck Penetration w/Welding Sleeve & Socket - EPDM 3-1/2" OD	098268276879	2.81	315.00
875.114.110 S	875.114.110 S	4"(110) SS Deck Penetration w/Welding Sleeve & Socket - EPDM 4-1/2" OD	098268276923	4.05	319.50
875.139.110 S	875.139.110 S	4"(110) SS Deck Penetration w/Welding Sleeve & Socket - EPDM 5-1/2" OD	098268276954	3.55	623.50
875.150.125 S	875.150.125 S	5"(125) SS Deck Penetration w/Welding Sleeve & Socket - EPDM	098268277029	4.68	834.50
875.168.160 S	875.168.160 S	6"(160) SS Deck Penetration w/Welding Sleeve & Socket - EPDM	098268277074	3.92	575.50
875.210.200 S	875.210.200 S	8"(200) SS Deck Penetration w/Welding Sleeve & Socket - EPDM	098268277098	7.8	921.50

Clamps & Hangers

Joint Clamps



Ordering Code	Model	Size/Description	UPC	Wt. (lbs.)	List Price
847.040.040	JC-1.5	1-1/2"(40) Stainless Steel Joint Clamp	098268183061	0.22	\$35.25
847.050.050	JC-2	2"(50) Stainless Steel Joint Clamp	098268183092	0.24	38.00
847.075.075	JC-3	3"(75) Stainless Steel Joint Clamp	098268183108	0.33	46.25
847.110.110	JC-4	4"(110) Stainless Steel Joint Clamp	098268183115	0.55	61.00
847.125.125	JC-5	5"(125) Stainless Steel Joint Clamp	098268183122	0.49	86.50
847.160.160	JC-6	6"(160) Stainless Steel Joint Clamp	098268183139	0.97	86.50
847.200.200	JC-8	8"(200) Stainless Steel Joint Clamp	098268183221	1.08	159.50
847.250.250	JC-10	10"(250) Stainless Steel Joint Clamp	098268223767	1.72	191.00

Peak Pressure Pipe Clamps



Ordering Code	Model	Size/Description	UPC	Wt. (lbs.)	List Price
847.001.040	PC-1.5	1-1/2"(40) Stainless Steel Peak Pressure Clamp	098268182958	1.01	\$215.00
847.001.050	PC-2	2"(50) Stainless Steel Peak Pressure Clamp	098268182989	1.10	215.00
847.001.075	PC-3	3"(75) Stainless Steel Peak Pressure Clamp	098268182996	1.26	237.50
847.001.110	PC-4	4"(110) Stainless Steel Peak Pressure Clamp	098268183009	2.16	345.00
847.001.160	PC-6	6"(160) Stainless Steel Peak Pressure Clamp	098268183023	3.22	574.00
847.001.200	PC-8	8"(200) Stainless Steel Peak Pressure Clamp	098268183030	4.01	1,005.00
847.001.250	PC-10	10"(250) Stainless Steel Peak Pressure Clamp	098268183047	5.67	1,292.00
847.001.315	PC-12	12"(315) Stainless Steel Peak Pressure Clamp	098268183054	6.72	1,578.00

Pipe Hangers



Ordering Code	Model	Size/Description	UPC	Wt. (lbs.)	List Price
860.040.050	PH-2	2"(50) Stainless Steel Pipe Hanger	098268216776	0.55	\$72.00
860.040.075	PH-3	3"(75) Stainless Steel Pipe Hanger	098268216783	0.66	86.50
860.040.110	PH-4	4"(110) Stainless Steel Pipe Hanger	098268216806	0.77	115.50
860.040.160	PH-6	6"(160) Stainless Steel Pipe Hanger	098268216813	0.93	144.00

2-Piece Pipe Hangers



Ordering Code	Model	Size/Description	UPC	Wt. (lbs.)	List Price
895.012.040 AGS	PH2-1.5-3/8	1-1/2"(40) Stainless Steel 2-Piece Pipe Hanger - 3/8" Thread	098268230505	0.37	\$72.00
895.012.040 GS	PH2-1.5-1/2	1-1/2"(40) Stainless Steel 2-Piece Pipe Hanger - 1/2" Thread	098268225426	0.37	72.00
895.012.050 AGS	PH2-2-3/8	2"(50) Stainless Steel 2-Piece Pipe Hanger - 3/8" Thread	098268225389	0.24	72.00
895.012.050 GS	PH2-2-1/2	2"(50) Stainless Steel 2-Piece Pipe Hanger - 1/2" Thread	098268225372	0.24	72.00
895.012.075 AGS	PH2-3-3/8	3"(75) Stainless Steel 2-Piece Pipe Hanger - 3/8" Thread	098268230864	0.31	101.00
895.012.075 GS	PH2-3-1/2	3"(75) Stainless Steel 2-Piece Pipe Hanger - 1/2" Thread	098268224788	0.31	101.00
895.012.110 AGS	PH2-4-3/8	4"(110) Stainless Steel 2-Piece Pipe Hanger - 3/8" Thread	098268224764	0.42	115.50
895.012.110 GS	PH2-4-1/2	4"(110) Stainless Steel 2-Piece Pipe Hanger - 1/2" Thread	098268224740	0.42	115.50
895.012.125 GS	PH2-5-1/2	5"(125) Stainless Steel 2-Piece Pipe Hanger - 1/2" Thread	098268230901	0.51	130.50
895.012.160 AGS	PH2-6-3/8	6"(160) Stainless Steel 2-Piece Pipe Hanger - 3/8" Thread	098268224733	0.60	136.50
895.012.160 GS	PH2-6-1/2	6"(160) Stainless Steel 2-Piece Pipe Hanger - 1/2" Thread	098268224719	0.60	136.50

Adjustable Pipe Hangers



Ordering Code	Model	Size/Description	UPC	Wt. (lbs.)	List Price
895.200.040 S	PHA-1.5	1-1/2"(40) Stainless Steel Adjustable Pipe Hanger	098268224696	0.26	\$72.00
895.200.050 S	PHA-2	2"(50) Stainless Steel Adjustable Pipe Hanger	098268224665	0.29	72.00
895.200.075 S	PHA-3	3"(75) Stainless Steel Adjustable Pipe Hanger	098268224627	0.40	101.00
895.200.110 S	PHA-4	4"(110) Stainless Steel Adjustable Pipe Hanger	098268224603	0.49	115.50
895.200.160 S	PHA-6	6"(160) Stainless Steel Adjustable Pipe Hanger	098268224580	0.66	136.50

Clamps & Hangers (Cont'd)



Sway Brace

Ordering Code	Model	Size/Description	UPC	Wt. (lbs.)	List Price
847.000.000	SB-1	Stainless Steel Sway Brace	098268182934	0.42	\$45.00

Socket Plugs



Push-In Socket Plugs

Ordering Code	Model	Size/Description	UPC	Wt. (lbs.)	List Price
844.000.040 S	PSP-1.5	1-1/2"(40) Stainless Steel Push-In Socket Plug	098268216721	0.15	\$40.25
844.000.050 S	PSP-2	2"(50) Stainless Steel Push-In Socket Plug	098268223316	0.22	40.25
844.000.075 S	PSP-3	3"(75) Stainless Steel Push-In Socket Plug	098268223347	0.22	49.50
844.000.110 S	PSP-4	4"(110) Stainless Steel Push-In Socket Plug	098268223385	0.37	62.00
844.000.125 S	PSP-5	5"(125) Stainless Steel Push-In Socket Plug	098268223682	0.64	84.75
844.000.160 S	PSP-6	6"(160) Stainless Steel Push-In Socket Plug	098268223705	0.90	110.00
844.000.200 S	PSP-8	8"(200) Stainless Steel Push-In Socket Plug	098268225327	1.34	176.00
844.000.250 S	PSP-10	10"(250) Stainless Steel Push-In Socket Plug	098268225358	2.51	372.50
844.000.315 S	PSP-12	12"(315) Stainless Steel Push-In Socket Plug	098268225365	5.89	917.00



Push-On Test Cap with 1/2" Tapped Connection

Ordering Code	Model	Size/Description	UPC	Wt. (lbs.)	List Price
844.069.050	PSP-2 W/Test Tap	2"(50) SS Push-On Test Cap w/1/2" Tapped Connection	098268218350	0.27	\$173.00
844.082.075	PSP-3 W/Test Tap	3"(75) SS Push-On Test Cap w/1/2" Tapped Connection	098268218367	0.57	195.00
844.087.110	PSP-4 W/Test Tap	4"(110) SS Push-On Test Cap w/1/2" Tapped Connection	098268218374	0.79	227.50



Compression Socket Plugs

Ordering Code	Model	Size/Description	UPC	Wt. (lbs.)	List Price
844.100.050 S	CSP-2	2"(50) Stainless Steel Compression Socket Plug	098268216738	0.35	\$83.00
844.100.075 S	CSP-3	3"(75) Stainless Steel Compression Socket Plug	098268226096	0.77	86.50
844.100.110 S	CSP-4	4"(110) Stainless Steel Compression Socket Plug	098268226102	0.84	115.50
845.000.160 S	CSP-6	6"(160) Stainless Steel Compression Socket Plug	098268226119	1.57	163.50

Cutting Tools & Accessories

Manual Pipe Cutting & Beveling Tools



Ordering Code	Model	Size/Description	UPC	Wt. (lbs.)	List Price
006.050.110	MPC-2-4	Manual Pipe Cutter - 2"(50) to 4"(110)	098268220841	22.27	\$3,872.00
006.125.200	MPC-5-8	Manual Pipe Cutter - 5"(125) to 8"(200)	098268221183	54.01	5,422.00
006.200.315	MPC-8-12	Manual Pipe Cutter - 8"(200) to 12"(315)	098268221244	77.16	27,119.00
006.000.005	MPC-S-2-4	Spindle for MPC-2-4 Pipe Cutter	098268240733	0.02	45.25
006.000.000	MPC-D-2-4	Cutting Disc for MPC-2-4	098268232158	0.02	17.00
006.000.001	MPC-D-5-8	Cutting Disc for MPC-5-8	098268232363	0.09	70.50

Electric Pipe Cutting & Beveling Tools



Ordering Code	Model	Size/Description	UPC	Wt. (lbs.)	List Price
800.050.160.US	EPC-2-6	110V Electric Pipe Cutter 2"(50) to 6"(160)	098268221282	95	\$35,839.00

Cutting Oil/Jointing Lubricant



Ordering Code	Model	Size/Description	UPC	Wt. (lbs.)	List Price
007.000.000	AT-1	Atomizer for Jointing Lubricant or Cutting Oil	098268232431	0.22	\$29.00
007.100.050	JL-1	Jointing Lubricant - 0.5 Liter	098268232189	1.10	63.00
007.500.050	CO-1	Cutting Oil - 0.5 Liter	098268232226	1.32	120.00

8" HygienicPro® Floor Drains - BFD-420-HG Series



8" Round Top HygienicPro® Floor Drains - Bottom Outlet

Ordering Code	Model	Size/Description	UPC	Wt. (lbs.)	List Price
BFD-423-HG	BFD-423-HG	8"(205) Round Top - 3"(75) Pipe - Bottom Outlet	098268244816	8.58	\$904.50
BFD-424-HG	BFD-424-HG	8"(205) Round Top - 4"(110) Pipe - Bottom Outlet	098268244823	8.66	904.50



8" Round Top HygienicPro® Floor Drains - Side Outlet

Ordering Code	Model	Size/Description	UPC	Wt. (lbs.)	List Price
BFD-423-SO-HG	BFD-423-SO-HG	8"(205) Round Top - 3"(75) Pipe - Side Outlet	098268247329	9.90	\$1,097.00
BFD-424-SO-HG	BFD-424-SO-HG	8"(205) Round Top - 4"(110) Pipe - Side Outlet	098268247336	8.69	1,097.00

NOTE: For BFD-420 options see page 27

12" HygienicPro® Floor Drains - BFD-570 Series - Low, Medium & High Depths



12" Round Top HygienicPro® Floor Drains - 4" Bottom Outlet

Ordering Code	Model	Size/Description	UPC	Wt. (lbs.)	List Price
BFD-574L	BFD-574L	12"(305) Round Top - 4"(110) Pipe - BO - 11"(277) H	098268247343	17.26	\$1,048.00
BFD-574M	BFD-574M	12"(305) Round Top - 4"(110) Pipe - BO - 15"(378) H	098268247350	19.36	1,103.00
BFD-574H	BFD-574H	12"(305) Round Top - 4"(110) Pipe - BO - 18"(455) H	098268247367	20.92	1,141.00



12" Round Top HygienicPro® Floor Drains - 4" Side Outlet

Ordering Code	Model	Size/Description	UPC	Wt. (lbs.)	List Price
BFD-574L-SO	BFD-574L-SO	12"(305) Round Top - 4"(110) Pipe - SO - 8"(198) H	098268247374	17.24	\$1,191.00
BFD-574M-SO	BFD-574M-SO	12"(305) Round Top - 4"(110) Pipe - SO - 12"(299) H	098268248807	19.40	1,248.00
BFD-574H-SO	BFD-574H-SO	12"(305) Round Top - 4"(110) Pipe - SO - 15"(376) H	098268248814	20.97	1,299.00



12" Round Top HygienicPro® Floor Drains - 6" Bottom Outlet

Ordering Code	Model	Size/Description	UPC	Wt. (lbs.)	List Price
BFD-576L	BFD-576L	12"(305) Round Top - 6"(160) Pipe - BO - 8"(202) H	098268247381	17.26	\$1,865.00
BFD-576M	BFD-576M	12"(305) Round Top - 6"(160) Pipe - BO - 12"(303) H	098268247398	19.36	1,937.00
BFD-576H	BFD-576H	12"(305) Round Top - 6"(160) Pipe - BO - 15"(380) H	098268247404	20.92	2,009.00

12" HygienicPro® HD Round Top Sanitary Floor Drain w/Bottom Outlet - BFD-580 Series



12" Round Heavy-Duty Top Sanitary Floor Drains - Bottom Outlet

Ordering Code	Model	Size/Description	UPC	Wt. (lbs.)	List Price
BFD-584	BFD-584	12"(300) Heavy-Duty Round Top - Sanitary FD - 4"(110) BO	098268355246	25.50	\$2,221.00
BFD-586	BFD-586	12"(300) Heavy-Duty Round Top - Sanitary FD - 6"(160) BO	098268355253	25.50	2,221.00

6" HygienicPro® Channel - BHG Series

6" HygienicPro® Channel - Standard Offering



Ordering Code	Model	Size/Description	UPC	Wt. (lbs.)	List Price
BHG-4EOM-X4	BHG-4EOM-X4	6"(147) W x 4'(1393) HP SS Trench Drain - 18" H End Out	098268248968	37.43	\$6,453.00
BHG-4EOM-X6	BHG-4EOM-X6	6"(147) W x 6'(1893) HP SS Trench Drain - 18" H End Out	098268248975	62.68	7,097.00
BHG-4EOM-X8	BHG-4EOM-X8	6"(147) W x 8'(2393) HP SS Trench Drain - 18" H End Out	098268248982	96.85	8,315.00
BHG-4COM-X8	BHG-4COM-X8	6"(147) W x 8'(2482) HP SS Trench Drain - 18" CTR Out	098268248999	97.44	8,315.00
BHG-4EOM-X11	BHG-4EOM-X11	6"(147) W x 11'(3409) HP SS Trench Drain - 19" H End Out	098268249002	136.40	11,040.00
BHG-4COM-X11	BHG-4COM-X11	6"(147) W x 11'(3492) HP SS Trench Drain - 18" H CTR Out	098268249019	133.45	11,040.00
BHG-4EOM-X14	BHG-4EOM-X14	6"(147) W x 14'(4417) HP SS Trench Drain - 19" H End Out	098268249026	167.84	13,549.00
BHG-4COM-X14	BHG-4COM-X14	6"(147) W x 14'(4482) HP SS Trench Drain - 18" H CTR Out	098268249033	168.08	13,549.00
BHG-4EOM-X18	BHG-4EOM-X18	6"(147) W x 18'(5425) HP SS Trench Drain - 19" H End Out	098268249040	205.01	16,774.00
BHG-4COM-X18	BHG-4COM-X18	6"(147) W x 18'(5523) HP SS Trench Drain - 18" H CTR Out	098268249057	189.86	16,774.00
BHG-4COM-X21	BHG-4COM-X21	6"(147) W x 21'(6516) HP SS Trench Drain - 18" H CTR Out	098268250022	217.00	18,816.00
BHG-4COM-X25	BHG-4COM-X25	6"(147) W x 25'(7532) HP SS Trench Drain - 18" H CTR Out	098268250039	281.00	22,400.00
BHG-4COM-X28	BHG-4COM-X28	6"(147) W x 28'(8532) HP SS Trench Drain - 18" H CTR Out	098268250053	315.00	25,088.00
BHG-4COM-X31	BHG-4COM-X31	6"(147) W x 31'(9548) HP SS Trench Drain - 18" H CTR Out	098268250046	334.00	27,776.00
BHG-4COM-X35	BHG-4COM-X35	6"(147) W x 35'(10548) HP SS Trench Drain - 18" H CTR Out	098268250060	384.00	31,360.00

Note: For Custom Lengths & Designs Contact Your BLÜCHER Representative.

Note: Above Models Come w/Medium (M) Depth Outlet. For Low Outlet (~ 3" shallower) Replace "M" w/"L"; High Outlet (~ 3" Deeper) Replace "M" w/"H"

HygienicClean®



Ordering Code	Model	Size/Description	UPC	Wt. (lbs.)	List Price
800.000.150	800.000.150	HygienicClean® - Channel & Grating Washer	098268218268	16.62	\$9,028.00

BHG Series Options

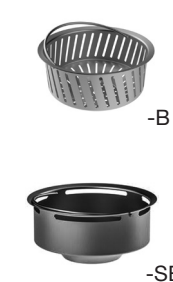

Ordering Suffix	Model	Size/Description	UPC	Wt. (lbs.)	List Price (ea)
-316	-316	Type 316L Stainless Steel	N/A	N/A	Add 20%
-B	BHB-1	Hygienic Sediment Basket - Low	098268240832	1.10	\$197.50
-B	BHB-2	Hygienic Sediment Basket - Medium	098268218114	2.16	197.50
-B	BHB-3	Hygienic Sediment Basket - High	098268218121	3.15	351.00
-SB	BSB-2	HygienicPro® Sand Bucket	098268213768	2.27	260.00
-CO	-CO	Center Outlet	N/A	N/A	NC

BHG Series Accessories

Ordering Code	Model	Size/Description	UPC	Wt. (lbs.)	List Price (ea)
780.005.150.05	780.005.150.05	HygienicPro® Filter 20"(500) Long	098268240771	1.96	\$257.50
670.000.010	670.000.010	Sediment Basket Spacer*	098268240795	0.60	43.75
670.000.020	670.000.020	Tile Adapter for End Outlets	098268240788	5.87	313.50
670.000.021	670.000.021	Tile Adapter for Center Outlets	098268240801	6.05	357.00
670.005.000	670.005.000	Funnel for Grating	098268218091	6.46	1,428.00
670.000.001	AL-1	Adjustable Legs for Installation - 6"(150) Max.	098268240818	0.33	28.00
670.000.005	AL-2	Adjustable Legs for Installation - 12"(300) Max.	098268248654	0.42	53.50
562.102.000 S	BWT-2T	Removable Water Trap	098268215786	1.76	350.50

*Spacer recommended for use with Sediment Basket



Filter



Spacer



Adapter

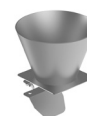

Funnel



-AL

Trench Drains - BT Series



Pre-Sloped Trench Drain with Mesh Grating - Stock - Center & End Outlet

Ordering Code	Model	Size/Description	UPC	Wt. (lbs.)	List Price
BT6-4EO-X5	BT6-4EO-X5	6"(147) x 5'(1540) with 4"(110) End Outlet	098268247411	51.82	\$3,450.00
BT6-4CO-X5	BT6-4CO-X5	6"(147) x 5'(1540) with 4"(110) Center Outlet	098268247248	52.19	3,450.00
BT6-4EO-X8	BT6-4EO-X8	6"(147) x 8'(2556) with 4"(110) End Outlet	098268247435	85.16	5,518.00
BT6-4EO-X10	BT6-4EO-X10	6"(147) x 10'(3056) with 4"(110) End Outlet	098268247442	101.21	6,898.00
BT6-4CO-X10	BT6-4CO-X10	6"(147) x 10'(3056) with 4"(110) Center Outlet	098268247459	102.80	6,898.00
BT6-4EO-X20	BT6-4EO-X20	6"(147) x 20'(6088) with 4"(110) End Outlet	098268247466	208.48	13,793.00
BT6-4CO-X20	BT6-4CO-X20	6"(147) x 20'(6088) with 4"(110) Center Outlet	098268247473	201.91	13,793.00
BT12-6EO-X5	BT12-6EO-X5	12"(297) x 5'(1540) with 6"(160) End Outlet	098268247480	86.33	6,533.00
BT12-6CO-X5	BT12-6CO-X5	12"(297) x 5'(1540) with 6"(160) Center Outlet	098268248678	86.70	6,533.00
BT12-6EO-X10	BT12-6EO-X10	12"(297) x 10'(3056) with 6"(160) End Outlet	098268247497	168.09	13,062.00
BT12-6CO-X10	BT12-6CO-X10	12"(297) x 10'(3056) with 6"(160) Center Outlet	098268248685	169.67	13,062.00

Pre-Sloped Trench Drain with Mesh Grating - Custom Lengths & Outlet Locations

Ordering Code	Model	Size/Description	UPC	Wt. (lbs.)	List Price (ft)
Contact Your BLÜCHER Representative	BT3	3"(77) W - Specify Length, Outlet Size & Location	N/A	Contact Your BLÜCHER Representative	\$548.00
	BT6	6"(147) W - Specify Length, Outlet Size & Location	N/A		660.50
	BT8	8"(197) W - Specify Length, Outlet Size & Location	N/A		990.00
	BT12	12"(297) W - Specify Length, Outlet Size & Location	N/A		1,252.00
	BT16	16"(397) W - Specify Length, Outlet Size & Location	N/A		Contact Your BLÜCHER Representative
	BT20	20"(497) W - Specify Length, Outlet Size & Location	N/A		
	BT24	24"(597) W - Specify Length, Outlet Size & Location	N/A		
	BT28	28"(697) W - Specify Length, Outlet Size & Location	N/A		
	BT32	32"(797) W - Specify Length, Outlet Size & Location	N/A		

Note: For trench drains 3 ft. and under, please contact your BLÜCHER representative.

Pre-Sloped Trench Drain w/Surface Clamp & Mesh Grating - Custom Lengths & Outlet Locations



Ordering Code	Model	Size/Description	UPC	Wt. (lbs.)	List Price (ft)
Contact Your BLÜCHER Representative	BTV6	6"(147) W - Specify Length, Outlet Size & Location	N/A	Contact Your BLÜCHER Representative	\$1,008.00
	BTV8	8"(197) W - Specify Length, Outlet Size & Location	N/A		1,508.00
	BTV12	12"(297) W - Specify Length, Outlet Size & Location	N/A		1,906.00
	BTV16	16"(397) W - Specify Length, Outlet Size & Location	N/A		Contact Your BLÜCHER Representative
	BTV20	20"(497) W - Specify Length, Outlet Size & Location	N/A		
	BTV24	24"(597) W - Specify Length, Outlet Size & Location	N/A		
	BTV28	28"(697) W - Specify Length, Outlet Size & Location	N/A		
	BTV32	32"(797) W - Specify Length, Outlet Size & Location	N/A		

Note: For trench drains 3 ft. and under, please contact your BLÜCHER representative.

Trench Drain Options - BT Series

BT Series Options



Ordering Suffix	Model	Size/Description	UPC	Wt. (lbs)	List Price
-316	-316	Type 316L Stainless Steel	N/A	N/A	Add 20%
-B	BB-1	4"(110) Sediment Basket	098268217179	0.71	\$107.00
-B	BB-2NS	6"(160) Sediment Basket	098268234169	0.66	89.25
-FC	-FC	Outlet with Membrane Clamp	N/A	N/A	313.50
-LD	-LD	Grate Locking Device	N/A	N/A	18.00/ft.
-O	-O	Outlet Box	N/A	N/A	Contact Your BLÜCHER Representative
-SB	BSB-1	6"(160) Sand bucket	N/A	N/A	245.00
-GC	-GC	Glass Catcher	N/A	N/A	1,906.00

Optional Accessories/Gratings - BT Series

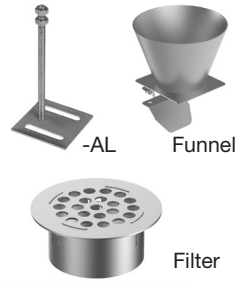

BT Series Accessories

Ordering Code	Model	Size/Description	UPC	Wt. (lbs)	List Price (ft)
670.005.000	670.005.000	Funnel for Grating	098268218091	6.46	\$1,428.00
670.000.001	AL-1	Adjustable Legs for Installation - 6"(150) Max.	098268240818	0.33	28.00
670.000.005	AL-2	Adjustable Legs for Installation - 12"(300) Max.	098268248654	0.42	53.50
670.000.006	FG-1	Frame Guard	098268248661	0.92	92.25
780.400.075.05	780.400.075.05	3"(75) Stainless Steel Secondary Outlet Filter	098268217193	0.29	99.50
780.400.110.05	780.400.110.05	4"(110) Stainless Steel Secondary Outlet Filter	098268217292	0.46	154.50
780.400.160.05	780.400.160.05	6"(160) Stainless Steel Secondary Outlet Filter	098268218138	1.08	145.00

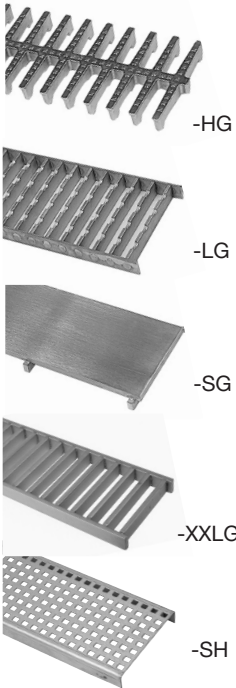

3", 6", 8" & 12" Grating Options

Ordering Suffix	Model	Size/Description	UPC	Wt. (lbs)	List Price Adder (ft)
-HG	BT3	3"(75) Wide SS Heavy Duty HygienicPro® Grate	N/A	Contact Your BLÜCHER Representative	\$226.50
-HG	BT6	6"(145) Wide SS Heavy Duty HygienicPro® Grate	N/A		253.50
-HG	BT8	8"(195) Wide SS Special Duty HygienicPro® Grate	N/A		320.50
-HG	BT12	12"(295) Wide SS Heavy Duty HygienicPro® Grate	N/A		348.50
-LG	BT3	3"(75) Wide SS Extra Heavy Duty Ladder Grate	N/A		163.00
-LG	BT6	6"(145) Wide SS Special Duty Ladder Grate	N/A		190.50
-LG	BT8	8"(195) Wide SS Extra Heavy Duty Ladder Grate	N/A		239.50
-LG	BT12	12"(295) Wide SS Extra Heavy Duty Ladder Grate	N/A		267.50
-SG	BT3	3"(75) Wide SS Heavy Duty Slot Grate	N/A		257.50
-SG	BT6	6"(145) Wide SS Extra Heavy Duty Slot Grate	N/A		285.00
-SG	BT8	8"(195) Wide SS Special Duty Slot Grate	N/A		383.50
-SG	BT12	12"(295) Wide SS Heavy Duty Slot Grate	N/A		411.50
-XXLG	BT3	3"(75) Wide SS Special Duty Ladder Grate	N/A	226.50	
-XXLG	BT6	6"(145) Wide SS Special Duty Ladder Grate	N/A	253.50	
-XXLG	BT8	8"(195) Wide SS Special Duty Ladder Grate	N/A	320.50	
-XXLG	BT12	12"(295) Wide SS Extra Heavy Duty Ladder Grate	N/A	348.50	
-SH	BT3, 6, 8	3"(75), 6"(145), 8"(195) W SS Shower Grate	N/A		No Add

16" & Above Grating Options

Ordering Suffix	Model	Size/Description	UPC	Wt. (lbs)	List Price Adder (ft)
-LG	-LG	SS Extra Heavy Duty Ladder Grate	N/A	Contact Your BLÜCHER Representative	Contact Your BLÜCHER Representative
-SG	-SG	SS Heavy Duty Slot Grate	N/A		Contact Your BLÜCHER Representative
-XXLG	-XXLG	SS Special Duty Ladder Grate	N/A		Contact Your BLÜCHER Representative

Trench Drains - BTS Series

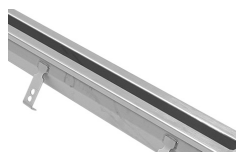

EZ Clean Slot Channel

Ordering Code	Model	Size/Description	UPC	Wt. (lbs)	List Price (ft)
Contact Your BLÜCHER Representative	BTS-EC	2"(60) W - Specify Length, Outlet Size, & Location	N/A	Contact Your BLÜCHER Representative	\$626.00



BTS Series Options

Ordering Suffix	Model	Size/Description	UPC	Wt. (lbs)	List Price
-316	-316	Type 316L Stainless Steel	N/A	N/A	Add 20%
-B	-B	Sediment Basket	N/A	N/A	\$89.75
-O	-O	With Round or Square Sump Outlet	N/A	N/A	Contact Your BLÜCHER Representative

8" Adjustable Floor Drains with Membrane Clamp - BFD-110 Series



8" Square Top - Adjustable Floor Drains With Membrane Clamp - Bottom Outlet

Ordering Code	Model	Size/Description	UPC	Wt. (lbs.)	List Price
BFD-113	BFD-113	8"(200) Sq. Top - Adj. FD w/ Membrane Clamp - 3"(75) BO	098268247503	15.77	\$1,134.00
BFD-114	BFD-114	8"(200) Sq. Top - Adj. FD w/ Membrane Clamp - 4"(110) BO	098268247510	15.86	1,134.00



8" Round Top - Adjustable Floor Drains With Membrane Clamp - Bottom Outlet

Ordering Code	Model	Size/Description	UPC	Wt. (lbs.)	List Price
BFD-113-R	BFD-113-R	8"(205) Rd. Top - Adj. FD w/ Membrane Clamp - 3"(75) BO	098268247537	15.50	1,134.00
BFD-114-R	BFD-114-R	8"(205) Rd. Top - Adj. FD w/ Membrane Clamp - 4"(110) BO	098268247534	15.59	1,134.00



8" Square Top - Adjustable Floor Drains With Membrane Clamp - Side Outlet

Ordering Code	Model	Size/Description	UPC	Wt. (lbs.)	List Price
BFD-113-SO	BFD-113-SO	8"(200) Sq. Top - Adj. FD w/ Membrane Clamp - 3"(75) SO	098268247541	16.94	1,278.00
BFD-114-SO	BFD-114-SO	8"(200) Sq. Top - Adj. FD w/ Membrane Clamp - 4"(110) SO	098268248708	16.06	1,278.00



8" Round Top - Adjustable Floor Drains With Membrane Clamp - Side Outlet

Ordering Code	Model	Size/Description	UPC	Wt. (lbs.)	List Price
BFD-113-R-SO	BFD-113-R-SO	8"(205) Rd. Top - Adj. FD w/ Membrane Clamp - 3"(75) SO	098268248715	16.67	1,278.00
BFD-114-R-SO	BFD-114-R-SO	8"(205) Rd. Top - Adj. FD w/ Membrane Clamp - 4"(110) SO	098268248722	15.79	1,278.00

8" Adjustable Floor Drains for On-Grade - BFD-210 Series



8" Square Top - Adjustable Floor Drains For On-Grade - Bottom Outlet

Ordering Code	Model	Size/Description	UPC	Wt. (lbs.)	List Price
BFD-213	BFD-213	8"(200) Sq. Top - Adj. FD for On-Grade - 3"(75) BO	098268247558	9.49	\$636.00
BFD-214	BFD-214	8"(200) Sq. Top - Adj. FD for On-Grade - 4"(110) BO	098268247565	9.57	636.00



8" Round Top - Adjustable Floor Drains For On-Grade - Bottom Outlet

Ordering Code	Model	Size/Description	UPC	Wt. (lbs.)	List Price
BFD-213-R	BFD-213-R	8"(205) Rd. Top - Adj. FD for On-Grade - 3"(75) BO	098268247572	9.22	636.00
BFD-214-R	BFD-214-R	8"(205) Rd. Top - Adj. FD for On-Grade - 4"(110) BO	098268247589	9.31	636.00



8" Square Top - Adjustable Floor Drains For On-Grade - Side Outlet

Ordering Code	Model	Size/Description	UPC	Wt. (lbs.)	List Price
BFD-213-SO	BFD-213-SO	8"(200) Sq. Top - Adj. FD for On-Grade - 3"(75) SO	098268247596	10.57	788.50
BFD-214-SO	BFD-214-SO	8"(200) Sq. Top - Adj. FD for On-Grade - 4"(110) SO	098268248746	9.60	788.50



8" Round Top - Adjustable Floor Drains For On-Grade - Side Outlet

Ordering Code	Model	Size/Description	UPC	Wt. (lbs.)	List Price
BFD-213-R-SO	BFD-213-R-SO	8"(205) Sq. Top - Adj. FD for On-Grade - 3"(75) SO	098268248739	20.30	788.50
BFD-214-R-SO	BFD-214-R-SO	8"(205) Sq. Top - Adj. FD for On-Grade - 4"(110) SO	098268247602	9.33	788.50

Note: All 8" drains come with 1/8" standard grate (as pictured)

8" Square Top Sanitary Floor Drains with Deep Body - BFD-310 Series



8" Square Top Sanitary Floor Drains With Deep Body - Bottom Outlet

Ordering Code	Model	Size/Description	UPC	Wt. (lbs.)	List Price
BFD-313	BFD-313	8"(200) Sq. Top - Sanitary FD w/ Deep Body - 3"(75) BO	098268247619	6.81	\$460.00
BFD-314	BFD-314	8"(200) Sq. Top - Sanitary FD w/ Deep Body - 4"(110) BO	098268247626	6.90	460.00



8" Square Top Sanitary Floor Drains With Deep Body - Side Outlet

Ordering Code	Model	Size/Description	UPC	Wt. (lbs.)	List Price
BFD-313-SO	BFD-313-SO	8"(200) Sq. Top - Sanitary FD w/ Deep Body - 3"(75) SO	098268248692	7.91	686.50
BFD-314-SO	BFD-314-SO	8"(200) Sq. Top - Sanitary FD w/ Deep Body - 4"(110) SO	098268247633	6.94	686.50

8" Round Top Sanitary Floor Drains with Deep Body - BFD-410 Series



8" Round Top Sanitary Floor Drains With Deep Body - Bottom Outlet

Ordering Code	Model	Size/Description	UPC	Wt. (lbs.)	List Price
BFD-413	BFD-413	8"(205) Rd. Top - Sanitary FD w/ Deep Body - 3"(75) BO	098268247640	6.65	732.00
BFD-414	BFD-414	8"(205) Rd. Top - Sanitary FD w/ Deep Body - 4"(110) BO	098268247657	6.74	732.00



8" Round Top Sanitary Floor Drains With Deep Body - Side Outlet

Ordering Code	Model	Size/Description	UPC	Wt. (lbs.)	List Price
BFD-413-SO	BFD-413-SO	8"(205) Rd. Top - Sanitary FD w/ Deep Body - 3"(75) SO	098268248753	7.75	732.00
BFD-414-SO	BFD-414-SO	8"(205) Rd. Top - Sanitary FD w/ Deep Body - 4"(110) SO	098268248760	6.79	732.00

8" Square Top Sanitary Floor Drains - BFD-320 Series



8" Square Top Sanitary Floor Drains - Bottom Outlet

Ordering Code	Model	Size/Description	UPC	Wt. (lbs.)	List Price
BFD-323	BFD-323	8"(200) Sq. Top - Sanitary FD - 3"(75) BO	098268247664	6.33	460.00
BFD-324	BFD-324	8"(200) Sq. Top - Sanitary FD - 4"(110) BO	098268247671	6.35	460.00



8" Square Top Sanitary Floor Drains - Side Outlet

Ordering Code	Model	Size/Description	UPC	Wt. (lbs.)	List Price
BFD-323-SO	BFD-323-SO	8"(200) Sq. Top - Sanitary FD - 3"(75) SO	098268247688	7.37	\$612.00
BFD-324-SO	BFD-324-SO	8"(200) Sq. Top - Sanitary FD - 4"(110) SO	098268247695	6.41	612.00

8" Round Top Sanitary Floor Drains - BFD-420 Series (Add -GT for gastight drain)



8" Round Top Sanitary Floor Drains - Bottom Outlet

Ordering Code	Model	Size/Description	UPC	Wt. (lbs.)	List Price
BFD-423	BFD-423	8"(205) Rd. Top - Sanitary FD - 3"(75) BO	098268247701	6.11	\$732.00
BFD-424	BFD-424	8"(205) Rd. Top - Sanitary FD - 4"(110) BO	098268247718	6.20	732.00



8" Round Top Sanitary Floor Drains - Side Outlet

Ordering Code	Model	Size/Description	UPC	Wt. (lbs.)	List Price
BFD-423-SO	BFD-423-SO	8"(205) Rd. Top - Sanitary FD - 3"(75) SO	098268247725	7.22	\$884.00
BFD-424-SO	BFD-424-SO	8"(205) Rd. Top - Sanitary FD - 4"(110) SO	098268247732	6.26	884.00

Note: All 8" drains come with 1/8" standard grate (as pictured)

8" Sanitary Floor Drains with Surface Membrane Clamp - BFD-510 Series

8" Round Top Sanitary Floor Drains With Surface Membrane Clamp - Bottom Outlet



Ordering Code	Model	Size/Description	UPC	Wt. (lbs.)	List Price
BFD-513	BFD-513	8"(205) Rd. Top - Sanitary FD w/ Surface Memb. Clamp - 3"(75) BO	098268247749	6.86	\$847.50
BFD-514	BFD-514	8"(205) Rd. Top - Sanitary FD w/ Surface Memb. Clamp - 4"(110) BO	098268247756	6.95	847.50

8" Round Top Sanitary Floor Drains With Surface Membrane Clamp - Side Outlet



Ordering Code	Model	Size/Description	UPC	Wt. (lbs.)	List Price
BFD-513-SO	BFD-513-SO	8"(205) Rd. Top - Sanitary FD w/ Surface Memb. Clamp - 3"(75) SO	098268248784	7.96	\$1,000.00
BFD-514-SO	BFD-514-SO	8"(205) Rd. Top - Sanitary FD w/ Surface Memb. Clamp - 4"(110) SO	098268248791	7.00	1,000.00

8" Sanitary Floor Drains with Elastomeric Flange - BFD-550 Series

8" Square Top Sanitary Floor Drains w/Elastomeric Flange - Bottom Outlet



Ordering Code	Model	Size/Description	UPC	Wt. (lbs.)	List Price
BFD-553	BFD-553	8"(200) Sq. Top - Sanitary FD w/ Elastomeric Flange - 3"(75) BO	098268247763	7.94	\$844.50
BFD-554	BFD-554	8"(200) Sq. Top - Sanitary FD w/ Elastomeric Flange - 4"(110) BO	098268247770	8.02	844.50

8" Optional Gratings - BFD Series

8" Square Gratings (1/2 & 3/4 grates available. Contact your BLUCHER Rep for information)

Ordering Suffix	Model	Size/Description	UPC	Wt. (lbs.)	Price Adder
-HG	BHG-8	6-5/8"(168) Square SS Heavy Duty HygienicPro® Grate	098268240863	4.41	\$320.00
-LG	BLG-8	6-5/8"(168) Square SS Extra Heavy Duty Ladder Grate	098268233889	3.79	282.00
-MG	BMG-8	6-5/8"(168) Square SS Heavy Duty Mesh Grate	098268234176	2.31	229.00
-SG	BSG-8	6-5/8"(168) Square SS Heavy Duty Slot Grate	098268233865	4.54	359.50
-XXLG	BXXLG-8	6-5/8"(168) Square SS Fully Welded Ladder Grate	098268258554	4.34	397.50



-HG

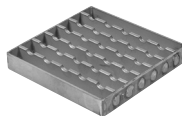

-LG

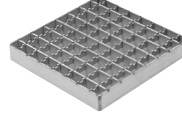

-MG



-SG



-XXLG

8" Round Gratings (1/2 & 3/4 grates available. Contact your BLUCHER Rep for information)

Ordering Suffix	Model	Size/Description	UPC	Wt. (lbs.)	Price Adder
-HG	BHG-8R	6-13/16"(173) Round SS Heavy Duty HygienicPro® Grate	098268240894	3.73	\$320.00
-LG	BLG-8R	6-13/16"(173) Round SS Extra Heavy Duty Ladder Grate	098268238310	1.98	282.00
-MG	BMG-8R	6-13/16"(173) Round SS Heavy Duty Mesh Grate	098268234206	1.17	216.50
-SG	BSG-8R	6-13/16"(173) Round SS Heavy Duty Slot Grate	098268234992	4.45	359.50
-GT	BGT-8R	6-13/16"(173) Round SS Heavy Duty Gastight Grate	098268230376	5.32	579.00
-XXLG	BXXLG-8R	6-13/16"(173) Round SS XHD Fully Welded Ladder Grate	098268258622	6.61	397.50



-HG



-LG

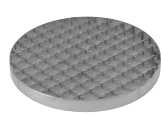

-MG



-SG



-GT



-XXLG

Note: All 8" drains come with 1/8" standard grate (as pictured)

8" Gastight Floor Drains - BFD-610 Series

8" Gastight Floor Drains

Ordering Code	Model	Size/Description	UPC	Wt. (lbs.)	List Price
BFD-613	BFD-613	8"(200) Sq. Top - Gastight Floor Drain - 3"(75) Pipe - BO	098268234503	14.14	\$3,420.00
BFD-614	BFD-614	8"(200) Sq. Top - Gastight Floor Drain - 4"(110) Pipe- BO	098268234510	14.22	3,322.00

8" Gastight Drain Options - BFD 610 Series

Options

Ordering Suffix	Model	Size/Description	UPC	Wt. (lbs.)	Price Adder
-B	BB-2NS	6"(160) Sediment Basket	098268234169	0.66	\$95.25
-TPT	TPT	Trap Primer Tapping	N/A	2.16	296.00

Note: See page 28 for Vacuum Handle

12" Adjustable Floor Drains with Membrane Clamp - BFD-130 Series



12" Square Top - Adjustable Floor Drains With Membrane Clamp - Bottom Outlet

Ordering Code	Model	Size/Description	UPC	Wt. (lbs.)	List Price
BFD-134	BFD-134	12"(300) Sq. Top - Adj. FD w/ Membrane Clamp - 4"(110) BO	098268247787	26.39	\$1,590.00
BFD-136	BFD-136	12"(300) Sq. Top - Adj. FD w/ Membrane Clamp - 6"(160) BO	098268247794	26.68	1,590.00



12" Round Top - Adjustable Floor Drains With Membrane Clamp - Bottom Outlet

Ordering Code	Model	Size/Description	UPC	Wt. (lbs.)	List Price
BFD-134-R	BFD-134-R	12"(305) Rd. Top - Adj. FD w/ Membrane Clamp - 4"(110) BO	098268247800	25.79	\$1,590.00
BFD-136-R	BFD-136-R	12"(305) Rd. Top - Adj. FD w/ Membrane Clamp - 6"(160) BO	098268248777	26.10	1,590.00



12" Square Top - Adjustable Floor Drains With Membrane Clamp - Side Outlet

Ordering Code	Model	Size/Description	UPC	Wt. (lbs.)	List Price
BFD-134-SO	BFD-134-SO	12"(300) Sq. Top - Adj. FD w/ Membrane Clamp - 4"(110) SO	098268247817	26.64	\$1,945.00
BFD-136-SO	BFD-136-SO	12"(300) Sq. Top - Adj. FD w/ Membrane Clamp - 6"(160) SO	098268248821	28.54	1,945.00



12" Round Top - Adjustable Floor Drains With Membrane Clamp - Side Outlet

Ordering Code	Model	Size/Description	UPC	Wt. (lbs.)	List Price
BFD-134-R-SO	BFD-134-R-SO	12"(305) Rd. Top - Adj. FD w/ Membrane Clamp - 4"(110) SO	098268248838	26.05	\$1,945.00
BFD-136-R-SO	BFD-136-R-SO	12"(305) Rd. Top - Adj. FD w/ Membrane Clamp - 6"(160) SO	098268248845	27.95	1,945.00

12" Adjustable Floor Drains for On-Grade - BFD-230 Series



12" Square Top - Adjustable Floor Drains For On-Grade - Bottom Outlet

Ordering Code	Model	Size/Description	UPC	Wt. (lbs.)	List Price
BFD-234	BFD-234	12"(300) Sq. Top - Adj. FD for On-Grade - 4"(110) BO	098268247824	17.75	\$1,065.00
BFD-236	BFD-236	12"(300) Sq. Top - Adj. FD for On-Grade - 6"(160) BO	098268247831	18.05	1,065.00



12" Round Top - Adjustable Floor Drains For On-Grade - Bottom Outlet

Ordering Code	Model	Size/Description	UPC	Wt. (lbs.)	List Price
BFD-234-R	BFD-234-R	12"(305) Rd. Top - Adj. FD for On-Grade - 4"(110) BO	098268247848	17.15	\$1,065.00
BFD-236-R	BFD-236-R	12"(305) Rd. Top - Adj. FD for On-Grade - 6"(160) BO	098268247855	17.46	1,065.00



12" Square Top - Adjustable Floor Drains For On-Grade - Side Outlet

Ordering Code	Model	Size/Description	UPC	Wt. (lbs.)	List Price
BFD-234-SO	BFD-234-SO	12"(300) Sq. Top - Adj. FD for On-Grade - 4"(110) SO	098268247862	18.00	\$1,217.00
BFD-236-SO	BFD-236-SO	12"(300) Sq. Top - Adj. FD for On-Grade - 6"(160) SO	098268248852	20.10	1,217.00



12" Round Top - Adjustable Floor Drains For On-Grade - Side Outlet

Ordering Code	Model	Size/Description	UPC	Wt. (lbs.)	List Price
BFD-234-R-SO	BFD-234-R-SO	12"(305) Rd. Top - Adj. FD for On-Grade - 4"(110) SO	098268248869	17.41	\$1,217.00
BFD-236-R-SO	BFD-236-R-SO	12"(305) Rd. Top - Adj. FD for On-Grade - 6"(160) SO	098268248876	19.51	1,217.00

Note: All 12" drains come with 1/8" standard grate (as pictured)

12" Sanitary Floor Drains - BFD-340 Series



12" Square Top Sanitary Floor Drains - Bottom Outlet

Ordering Code	Model	Size/Description	UPC	Wt. (lbs.)	List Price
BFD-343	BFD-343	12"(300) Sq. Top - Sanitary FD - 3"(75) BO	098268247879	14.64	\$916.00
BFD-344	BFD-344	12"(300) Sq. Top - Sanitary FD - 4"(110) BO	098268247886	14.64	916.00
BFD-346	BFD-346	12"(300) Sq. Top - Sanitary FD - 6"(160) BO	098268247893	14.88	916.00
BFD-348	BFD-348	12"(300) Sq. Top - Sanitary FD - 8"(200) BO	098268272710	14.91	1,010.00



12" Square Top Sanitary Floor Drains - Side Outlet

Ordering Code	Model	Size/Description	UPC	Wt. (lbs.)	List Price
BFD-344-SO	BFD-344-SO	12"(300) Sq. Top - Sanitary FD - 4"(110) SO	098268247909	14.04	\$1,068.00
BFD-346-SO	BFD-346-SO	12"(300) Sq. Top - Sanitary FD - 6"(160) SO	098268247916	13.35	1,068.00

12" Sanitary Floor Drains - BFD-440 Series



12" Round Top Sanitary Floor Drains - Bottom Outlet

Ordering Code	Model	Size/Description	UPC	Wt. (lbs.)	List Price
BFD-443	BFD-443	12"(305) Rd. Top - Sanitary FD - 3"(75) BO	098268247923	14.60	\$1,328.00
BFD-444	BFD-444	12"(305) Rd. Top - Sanitary FD - 4"(110) BO	098268247930	14.72	1,328.00
BFD-446	BFD-446	12"(305) Rd. Top - Sanitary FD - 6"(160) BO	098268247947	14.84	1,328.00



12" Round Top Sanitary Floor Drains - Side Outlet

Ordering Code	Model	Size/Description	UPC	Wt. (lbs.)	List Price
BFD-444-SO	BFD-444-SO	12"(305) Rd. Top - Sanitary FD - 4"(110) SO	098268248883	13.85	\$1,480.00
BFD-446-SO	BFD-446-SO	12"(305) Rd. Top - Sanitary FD - 6"(160) SO	098268248890	13.96	1,480.00

12" Sanitary Floor Drains with Surface Membrane Clamp - BFD-530 Series



12" Round Top Sanitary Floor Drains With Surface Membrane Clamp - Bottom Outlet

Ordering Code	Model	Size/Description	UPC	Wt. (lbs.)	List Price
BFD-534	BFD-534	12"(305) Rd. Top - Sanitary FD w/ Surface Memb. Clamp - 4"(110) BO	098268247954	15.21	\$1,443.00
BFD-536	BFD-536	12"(305) Rd. Top - Sanitary FD w/ Surface Memb. Clamp - 6"(160) BO	098268248906	13.96	1,443.00



12" Round Top Sanitary Floor Drains With Surface Membrane Clamp - Side Outlet

Ordering Code	Model	Size/Description	UPC	Wt. (lbs.)	List Price
BFD-534-SO	BFD-534-SO	12"(305) Rd. Top - Sanitary FD w/ Surface Memb. Clamp - 4"(110) SO	098268248913	14.62	\$1,594.00
BFD-536-SO	BFD-536-SO	12"(305) Rd. Top - Sanitary FD w/ Surface Memb. Clamp - 6"(160) SO	098268248920	14.62	1,594.00

12" Sanitary Floor Drains with Elastomeric Flange - BFD-560 Series



12" Square Top Sanitary Floor Drains With Elastomeric Flange

Ordering Code	Model	Size/Description	UPC	Wt. (lbs.)	List Price
BFD-563	BFD-563	12"(300) Sq. Top - Sanitary FD w/ Elastomeric Flange - 3"(75) BO	098268247961	14.64	\$1,300.00
BFD-564	BFD-564	12"(300) Sq. Top - Sanitary FD w/ Elastomeric Flange - 4"(110) BO	098268247978	14.19	1,300.00
BFD-566	BFD-566	12"(300) Sq. Top - Sanitary FD w/ Elastomeric Flange - 6"(160) BO	098268248937	13.33	1,300.00

Note: All 12" drains come with 1/8" standard grate (as pictured)

12" Optional Gratings - BFD Series (1/2 & 3/4 grates available. Contact your BLUCHER Rep for information)

12" Square Gratings

Ordering Suffix	Model	Size/Description	UPC	Wt. (lbs.)	Price Adder
-HG	BHG-12	12"(268) Square SS Heavy Duty HygienicPro® Grate	098268240917	11.82	\$739.50
-LG	BLG-12	12"(268) Square SS Extra Heavy Duty Ladder Grate	098268234268	11.53	519.50
-MG	BMG-12	12"(268) Square SS Heavy Duty Mesh Grate	098268238389	3.68	308.50
-SG	BSG-12	12"(268) Square SS Heavy Duty Slot Grate	098268238341	11.27	506.00
-XXLG	BXXLG-12	12"(268) Square SS XHD Fully Welded Ladder Grate	098268258707	10.63	655.50



-HG

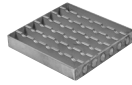

-LG

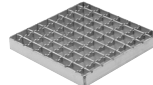

-MG



-SG



-XXLG

12" Round Grating

Ordering Suffix	Model	Size/Description	UPC	Wt. (lbs.)	Price Adder
-HG	BHG-12R	12"(273) Round SS Heavy Duty HygienicPro® Grate	098268238341	9.77	\$739.50
-LG	BLG-12R	12"(273) Round SS Extra Heavy Duty Ladder Grate	098268234336	2.16	519.50
-MG	BMG-12R	12"(273) Round SS Heavy Duty Mesh Grate	098268234305	2.16	308.50
-SG	BSG-12R-316	12"(273) Round SS Heavy Duty Slot Grate	098268204735	10.81	1,008.00
-GT	BGT-12R	12"(273) Round SS Heavy Duty Gastight Grate	098268230376	5.32	579.00
-XXLG	BXXLG-12R	12"(273) Round SS XHD Fully Welded Ladder Grate	098268233063	9.59	655.50



-HG



-LG

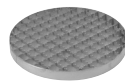

-MG



-SG



-GT



-XXLG

8" & 12" Drain Options - BFD Series

Options

Ordering Suffix	Size/Description	UPC	Wt. (lbs.)	Price Adder
-316	Type 316L Stainless Steel	N/A	N/A	Add 20%
-B	8" (200) Stainless Steel Sediment Basket	098268217131	0.66	\$95.25
-B	12" (300) Stainless Steel Sediment Basket	098268218114	1.48	197.50
-SB	8"(200) Stainless Steel Sand Bucket	098268233810	0.66	95.25
-SB	12"(300) Stainless Steel Sand Bucket	098268217148	1.72	197.50
-TPT	Trap Primer Tapping	N/A	N/A	296.00
-VP	Vandal Proof Screws	N/A	N/A	204.00



-B



-SB

Floor Cleanouts - BCO Series



Floor Cleanout with Square Top & Pull Nipple

Ordering Code	Model	Size/Description	UPC	Wt. (lbs.)	List Price
144.150.075 S	BCO-113-316	5-3/4"(145) x 5-3/4"(145) SS Floor Cleanout - Sq. Top - 3"(75) Pipe	098268190311	3.26	\$709.50
144.150.110 S	BCO-114-316	5-3/4"(145) x 5-3/4"(145) SS Floor Cleanout - Sq. Top - 4"(110) Pipe	098268190335	3.00	709.50
144.200.160 S	BCO-116-316	8"(200) x 8"(200) SS Floor Cleanout - Sq. Top - 6"(160) Pipe	098268191042	6.95	1,236.00



Floor Cleanout with Square Top (For Vacuum Handle)

Ordering Code	Model	Size/Description	UPC	Wt. (lbs.)	List Price
144.155.075 S	BCO-123-316	5-3/4"(145) x 5-3/4"(145) SS Floor Cleanout - Sq. Top - 3"(75) Pipe	098268190847	3.04	\$709.50
144.155.110 S	BCO-124-316	5-3/4"(145) x 5-3/4"(145) SS Floor Cleanout - Sq. Top - 4"(110) Pipe	098268190908	2.78	709.50
144.205.160 S	BCO-126-316	8"(200) x 8"(200) SS Floor Cleanout - Sq. Top - 6"(160) Pipe	098268191639	6.75	1,236.00

Note: Models above come with screw down covers.



Heavy Duty Floor Cleanout with Square Top (For Vacuum Handle)

Ordering Code	Model	Size/Description	UPC	Wt. (lbs.)	List Price
144.155.110.10 S	BCO-134-316	6-1/8"(155) x 6-1/8"(155) HD SS FCO - Sq. Top - 4"(110) Pipe	098268214109	6.94	\$864.00
144.205.160.10 S	BCO-136-316	8"(200) x 8"(200) HD SS FCO - Sq. Top - 6"(160) Pipe	098268191691	7.76	1,392.00
199-19053-01 S	BCO-138-316	12"(300) x 12"(300) HD SS FCO - Sq. Top - 8"(200) Pipe	098268274158	22.56	2,791.00

Note: Models above come with screw down covers.



Floor Cleanout with Round Top & Pull Nipple

Ordering Code	Model	Size/Description	UPC	Wt. (lbs.)	List Price
199-13488-04 S	BCO-143-316	7-1/8"(180) SS Floor Cleanout - Round Top - 3"(75) Pipe	098268240412	1.26	\$709.50
199-13488-01 S	BCO-144-316	7-1/8"(180) SS Floor Cleanout - Round Top - 4"(110) Pipe	098268240320	2.68	709.50



Floor Cleanout with Round Top (For Vacuum Handle)

Ordering Code	Model	Size/Description	UPC	Wt. (lbs.)	List Price
199-13488-05 S	BCO-153-316	7-1/8"(180) SS Floor Cleanout - Round Top - 3"(75) Pipe	098268240405	2.25	\$709.50
199-13488-02 S	BCO-154-316	7-1/8"(180) SS Floor Cleanout - Round Top - 4"(110) Pipe	098268240399	2.52	709.50



Floor Cleanout with Surface Membrane Clamp (For Vacuum Handle)

Ordering Code	Model	Size/Description	UPC	Wt. (lbs.)	List Price
244.155.110 S	BCO-224-316	8-3/4"(222) SS Floor Cleanout - Membrane Clamp - 4"(110) Pipe	098268192285	4.41	\$924.00

Note: Models above come with screw down covers.



Gastight Vacuum Handles

Ordering Code	Model	Size/Description	UPC	Wt. (lbs.)	List Price
700.000.003	BFD-VH6	6"(160) Round Vacuum Handle For Floor Cleanouts	098268216936	2.20	\$517.50

Floor Cleanouts - BCO Series



Heavy Duty Floor Cleanout with Round Top & Cast Body

Ordering Code	Model	Size/Description	UPC	Wt. (lbs.)	List Price
BCO-1203-RX-28	BCO-1203-RX-28	5-1/8"(130) SS Floor Cleanout w/Round Top & Cast Body - 3"(76) Pipe	098268280241	11.13	\$2,785.00
BCO-1204-RX-28	BCO-1204-RX-28	5-1/8"(130) SS Floor Cleanout w/Round Top & Cast Body - 4"(102) Pipe	098268280258	11.13	3,289.00

Trap Primer Adapters - BTPC Series



Trap Primer Adapters

Ordering Code	Model	Size/Description	UPC	Wt. (lbs.)	List Price
899-12911-07S	BTPC-2-316	2"(50) Stainless Steel Trap Prime Adapter	098268230956	0.56	\$359.50
899-12911-08S	BTPC-3-316	3"(75) Stainless Steel Trap Prime Adapter	098268230963	0.81	445.50
899-12911-10S	BTPC-4-316	4"(110) Stainless Steel Trap Prime Adapter	098268230970	1.22	430.50
899-12911-12S	BTPC-6-316	6"(160) Stainless Steel Trap Prime Adapter	098268230987	2.27	646.00

Hub Drains - BHD-100 Series

**No longer available.
Replaced by BHD-200 - See Below**

Hygienic Hub Drains - BHD-200 Series



Hygienic Hub Drains

Ordering Code	Model	Size/Description	UPC	Wt. (lbs.)	List Price
799-15306-06	BHD-202	2"(50) x 6"(160) Stainless Steel Hygienic Hub Drain	098268277791	2.56	\$205.00
799-15306-07	BHD-203	3"(75) x 6"(160) Stainless Steel Hygienic Hub Drain	098268277838	2.56	226.00
799-15306-10	BHD-204	4"(110) x 6"(160) Stainless Steel Hygienic Hub Drain	098268277920	2.71	247.00
799-15306-08	BHD-206	6"(160) x 10"(250) Stainless Steel Hygienic Hub Drain	098268277845	6.86	425.50
799-15306-09	BHD-208	8"(200) x 10"(250) Stainless Steel Hygienic Hub Drain	098268277890	7.52	436.00

Kitchen Channel - BKC Series

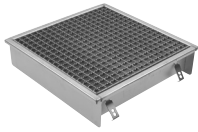

16" Square Kitchen Channel with Mesh Grating

Ordering Code	Model	Size/Description	UPC	Wt. (lbs.)	List Price
660FH004-06.22	BKC-104-2	16"(400) x 16"(400) x 2-3/8"(60) H - 4"(110) Pipe	098268248036	31.61	\$1,454.00
660FH004-11.22	BKC-104-4	16"(400) x 16"(400) x 4-5/16"(110) H - 4"(110) Pipe	098268248050	34.63	1,562.00
660FH004-15.22	BKC-104-6	16"(400) x 16"(400) x 5-7/8"(150) H - 4"(110) Pipe	098268248098	37.05	1,671.00
660FK004-06.22	BKC-106-2	16"(400) x 16"(400) x 2-3/8"(60) H - 6"(160) Pipe	098268248104	32.19	1,454.00
660FK004-11.22	BKC-106-4	16"(400) x 16"(400) x 4-5/16"(110) H - 6"(160) Pipe	098268248111	35.21	1,562.00
660FK004-15.22	BKC-106-6	16"(400) x 16"(400) x 5-7/8"(150) H - 6"(160) Pipe	098268248128	37.43	1,671.00

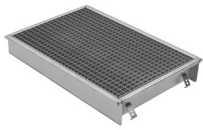

16" x 32" Kitchen Channel with Mesh Grating

Ordering Code	Model	Size/Description	UPC	Wt. (lbs.)	List Price
660FH008-06.22	BKC-204-2	16"(400) x 32"(800) x 2-3/8"(60) H - 4"(110) Pipe	098268248074	60.55	\$2,234.00
660FH008-11.22	BKC-204-4	16"(400) x 32"(800) x 4-5/16"(110) H - 4"(110) Pipe	098268248135	65.02	2,342.00
660FH008-15.22	BKC-204-6	16"(400) x 32"(800) x 5-7/8"(150) H - 4"(110) Pipe	098268248142	68.37	2,452.00
660FK008-06.22	BKC-206-2	16"(400) x 32"(800) x 2-3/8"(60) H - 6"(160) Pipe	098268248159	61.21	2,234.00
660FK008-11.22	BKC-206-4	16"(400) x 32"(800) x 4-5/16"(110) H - 6"(160) Pipe	098268248166	65.40	2,342.00
660FK008-15.22	BKC-206-6	16"(400) x 32"(800) x 5-7/8"(150) H - 6"(160) Pipe	098268248173	68.84	2,452.00

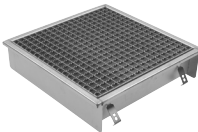

20" Square Kitchen Channel with Mesh Grating

Ordering Code	Model	Size/Description	UPC	Wt. (lbs.)	List Price
660GH005-06.22	BKC-304-2	20"(500) x 20"(500) x 2-3/8"(60) H - 4"(110) Pipe	098268248180	45.85	\$1,835.00
660GH005-11.22	BKC-304-4	20"(500) x 20"(500) x 4-5/16"(110) H - 4"(110) Pipe	098268248197	49.46	1,945.00
660GH005-15.22	BKC-304-6	20"(500) x 20"(500) x 5-7/8"(150) H - 4"(110) Pipe	098268248203	52.47	2,052.00
660GK005-06.22	BKC-306-2	20"(500) x 20"(500) x 2-3/8"(60) H - 6"(160) Pipe	098268248210	46.46	1,835.00
660GK005-11.22	BKC-306-4	20"(500) x 20"(500) x 4-5/16"(110) H - 6"(160) Pipe	098268248227	49.56	1,945.00
660GK005-15.22	BKC-304-6	20"(500) x 20"(500) x 5-7/8"(150) H - 6"(160) Pipe	098268248234	53.03	2,052.00

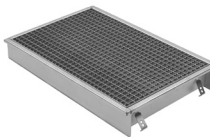

20" x 40" Kitchen Channel with Mesh Grating

Ordering Code	Model	Size/Description	UPC	Wt. (lbs.)	List Price
660GH010-15.22	BKC-404-6	20"(500) x 40"(1000) x 5-7/8"(150) H - 4"(110) Pipe	098268248241	98.07	\$3,104.00
660GH010-06.22	BKC-406-2	20"(500) x 40"(1000) x 2-3/8"(60) H - 6"(160) Pipe	098268248258	89.15	2,887.00
660GH010-11.22	BKC-406-4	20"(500) x 40"(1000) x 4-5/16"(110) H - 6"(160) Pipe	098268248265	94.39	2,995.00
660GH010-15.22	BKC-406-6	20"(500) x 40"(1000) x 5-7/8"(150) H - 6"(160) Pipe	098268248272	98.76	3,104.00

Series BKC Options

Ordering Code	Model	Size/Description	UPC	Wt. (lbs.)	Price Adder
-LG	-LG	Heavy Duty Ladder Grating for BKC-100 16"x16"	098268214635	14.42	\$412.50
-LG	-LG	Heavy Duty Ladder Grating for BKC-200 16"x16" Qty. 2	098268214635	28.84	823.50
-LG	-LG	Heavy Duty Ladder Grating for BKC-300 20"x20"	098268214840	22.31	549.00
-LG	-LG	Heavy Duty Ladder Grating for BKC-400 20"x20" Qty. 2	098268214840	44.62	1,098.00
-316	-316	Type 316L Stainless Steel	N/A	NA	Add 20%
-B	BB-1	4"(110)Sediment Basket	098268217179	0.71	107.00
-B	BB-2NS	6"(160) Sediment Basket	098268234169	0.66	89.25
-FC	-FC	Outlet With Membrane Clamp	N/A	N/A	313.50



-B



-LG

Lavatory/Shower Drains with Square Top - BSS Series



6" Square Lavatory/Shower Drain with Vienna Grating - Side Outlet

Ordering Code	Model	Size/Description	UPC	Wt. (lbs.)	List Price
312.300.050	BSS-102	6"(140) x 6"(140) Adj. SS Drain - Sq. Top - 2"(50) Pipe	098268234398	3.64	\$529.50



6" Square Lavatory/Shower Drain with Vienna Grating - Bottom Outlet

Ordering Code	Model	Size/Description	UPC	Wt. (lbs.)	List Price
352.300.050	BSS-302	6"(140) x 6"(140) Adj. SS Drain - Sq. Top - 2"(50) Pipe	098268234404	2.98	\$472.50
352.300.075	BSS-303	6"(140) x 6"(140) Adj. SS Drain - Sq. Top - 3"(75) Pipe	098268233711	2.98	472.50
352.300.110	BSS-304	6"(140) x 6"(140) Adj. SS Drain - Sq. Top - 4"(110) Pipe	098268214420	3.75	472.50

Series BSS Optional Gratings (No Additional Charge)

Ordering Code	Model	Size/Description	UPC	Wt. (lbs.)	List Price
-A	BSS-A	Athens 5-1/2"(140) Square Stainless Steel BSS Grate	098268214932	0.57	N/C
-C	BSS-C	Copenhagen 5-1/2"(140) Square Stainless Steel BSS Grate	098268233544	0.97	N/C
-D	BSS-D	Detroit 5-1/2"(140) Square Stainless Steel BSS Grate	098268233391	0.55	N/C
-N	BSS-N	New York 5-1/2"(140) Square Stainless Steel BSS Grate	098268233513	0.60	N/C
-O	BSS-O	Oslo 5-1/2"(140) Square Stainless Steel BSS Grate	098268233339	0.64	N/C

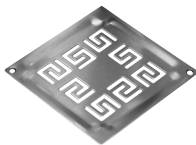

Athens

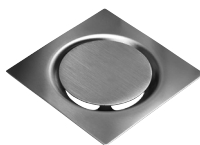

Copenhagen

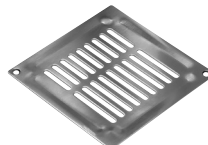

Detroit

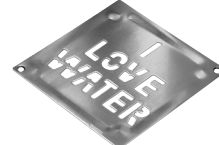

New York

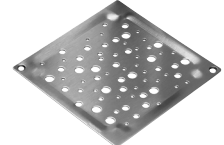

Oslo

Lavatory/Shower Drains with Surface Membrane Clamp - BSR Series



6" Round Lavatory/Shower Drain with Vienna Grating - Side Outlet

Ordering Code	Model	Size/Description	UPC	Wt. (lbs.)	List Price
210.300.050 S	BSR-702	6"(154) Adj. SS Drain - Round Top - 2"(50) Pipe	098268214222	2.89	\$878.50
210.300.075 S	BSR-703	6"(154) Adj. SS Drain - Round Top - 3"(75) Pipe	098268214239	2.98	878.50



6" Round Lavatory/Shower Drain with Vienna Grating - Bottom Outlet

Ordering Code	Model	Size/Description	UPC	Wt. (lbs.)	List Price
250.300.050	BSR-802	6"(154) Adj. SS Drain - Round Top - 2"(50) Pipe	098268214307	2.93	\$878.50
250.300.075	BSR-803	6"(154) Adj. SS Drain - Round Top - 3"(75) Pipe	098268214314	2.98	878.50
250.300.110	BSR-804	6"(154) Adj. SS Drain - Round Top - 4"(110) Pipe	098268214321	2.76	878.50

Series BSR Optional Gratings (No Additional Charge)

Ordering Code	Model	Size/Description	UPC	Wt. (lbs.)	List Price
-C	-C	Copenhagen 6"(154) Round Stainless Steel Grate	098268233919	1.50	N/C



WaterLine Lavatory/Shower Channel - BWC 100 Series

3-1/4" WaterLine Lavatory/Shower Channel with Vienna Grating & Membrane Clamp



Ordering Code	Model	Size/Description	UPC	Wt. (lbs.)	List Price
BWC-126	BWC-126	3-1/4"(82) x 26"(660) SS WaterLine Channel	098268248289	8.07	\$1,253.00
BWC-130	BWC-130	3-1/4"(82) x 30"(762) SS WaterLine Channel	098268248296	8.58	1,343.00
BWC-136	BWC-136	3-1/4"(82) x 36"(914) SS WaterLine Channel	098268248302	9.24	1,454.00
BWC-142	BWC-142	3-1/4"(82) x 42"(1067) SS WaterLine Channel	098268248319	9.95	1,583.00
BWC-148	BWC-148	3-1/4"(82) x 48"(1220) SS WaterLine Channel	098268248326	10.79	1,727.00
BWC-154	BWC-154	3-1/4"(82) x 54"(1372) SS WaterLine Channel	098268248333	11.68	2,008.00
BWC-160	BWC-160	3-1/4"(82) x 60"(1524) SS WaterLine Channel	098268248340	12.29	2,034.00
BWC-172	BWC-172	3-1/4"(82) x 72"(1829) SS WaterLine Channel	098268248357	13.50	2,342.00

WaterLine Lavatory/Shower Channel - BWS 200 Series

5-3/8" WaterLine Channel with Vienna Grating & Surface Clamp for Sheet Flooring



Ordering Code	Model	Size/Description	UPC	Wt. (lbs.)	List Price
BWS-228	BWS-228	5-3/8"(135) x 27-1/2"(700) SS WaterLine Channel	098268248364	6.02	\$1,599.00
BWS-232	BWS-232	5-3/8"(135) x 31-1/2"(800) SS WaterLine Channel	098268248371	6.82	1,743.00
BWS-236	BWS-236	5-3/8"(135) x 35-1/2"(900) SS WaterLine Channel	098268248388	7.61	1,888.00
BWS-240	BWS-240	5-3/8"(135) x 39-1/2"(1000) SS WaterLine Channel	098268248401	8.43	2,034.00

WaterLine Lavatory/Shower Channel - BWS 300 Series

Ligature Resistant Shower Channel



Ordering Code	Model	Size/Description	UPC	Wt. (lbs.)	List Price
BWS-312	BWS-312	5-3/8" x 12" SS Ligature Resistant Shower Channel	098268516784	3.80	\$1,500.00
BWS-324	BWS-324	5-3/8" x 24" SS Ligature Resistant Shower Channel	098268516807	7.70	1,750.00
BWS-330	BWS-330	5-3/8" x 30" SS Ligature Resistant Shower Channel	098268516760	9.60	1,915.00
BWS-336	BWS-336	5-3/8" x 36" SS Ligature Resistant Shower Channel	098268516746	11.30	2,075.00
BWS-342	BWS-342	5-3/8" x 42" SS Ligature Resistant Shower Channel	098268516845	13.40	2,235.00
BWS-348	BWS-348	5-3/8" x 48" SS Ligature Resistant Shower Channel	098268516869	15.40	2,500.00
BWS-360	BWS-360	5-3/8" x 60" SS Ligature Resistant Shower Channel	098268517118	19.20	2,650.00

Ligature Resistant Shower Channel with Membrane Clamp

Ordering Code	Model	Size/Description	UPC	Wt. (lbs.)	List Price
BWS-312-FC	BWS-312-FC	4" x 12" SS LR Shower Channel w/Membrane Clamp	098268517682	3.80	\$1,650.00
BWS-324-FC	BWS-324-FC	4" x 24" SS LR Shower Channel w/Membrane Clamp	098268517729	7.70	1,835.00
BWS-330-FC	BWS-330-FC	4" x 30" SS LR Shower Channel w/Membrane Clamp	098268517828	9.60	2,005.00
BWS-336-FC	BWS-336-FC	4" x 36" SS LR Shower Channel w/Membrane Clamp	098268517965	11.30	2,170.00
BWS-342-FC	BWS-342-FC	4" x 42" SS LR Shower Channel w/Membrane Clamp	098268517996	13.40	2,340.00
BWS-348-FC	BWS-348-FC	4" x 48" SS LR Shower Channel w/Membrane Clamp	098268518023	15.40	2,750.00
BWS-360-FC	BWS-360-FC	4" x 60" SS LR Shower Channel w/Membrane Clamp	098268518061	19.20	2,915.00

Series BWC/BWS Optional Gratings

Ordering Suffix	Model	Size/Description	UPC	Wt. (lbs.)	Price Adder
-A	-A	Stainless Steel Athens Grate	N/A	Contact Your BLÜCHER Representative	Contact Your BLÜCHER Representative
-C	-C	Stainless Steel Copenhagen Grate	N/A		
-D	-D	Stainless Steel Detroit Grate	N/A		
-O	-O	Stainless Steel Oslo Grate	N/A		
-T	-T	Stainless Steel Tokyo Tile Grate - Max. length 3' 3"(1000)	N/A		
-Q	-Q	Stainless Steel Custom Grate - 100pc Minimum	N/A		

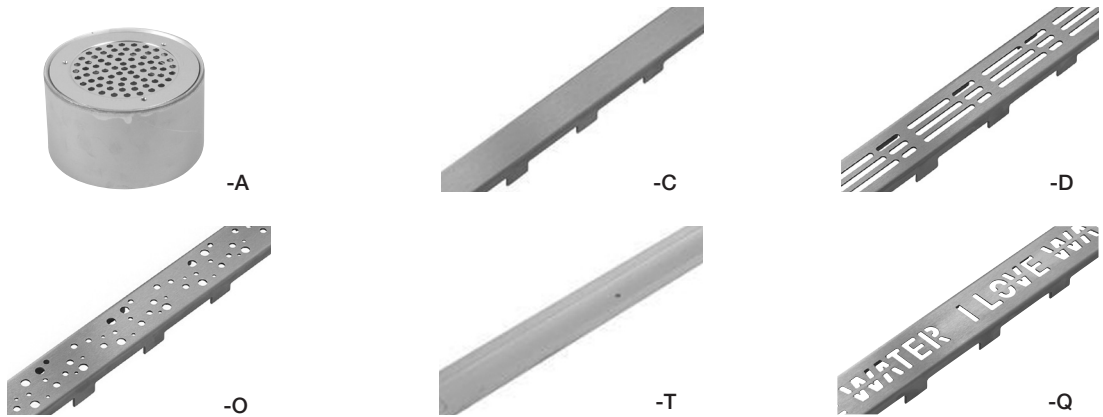

Series BWC/BWS Options

Ordering Suffix	Model	Size/Description	UPC	Wt. (lbs.)	Price Adder
-60	-60	2"(50) PVC Socket Connection	N/A	N/A	N/C
-61	-61	2"(50) ABC Socket Connection	N/A	N/A	N/C
-EO	-EO	2"(50) End Outlet Connection	N/A	N/A	N/C
-THD	-THD	2"(50) Threaded Connection	N/A	N/A	N/C
-VP	-VP	Vandal Proofing	N/A	N/A	N/C

Adapters

DIN Universal Flange Adapter with Socket - PN16 DIN 2633/EN1092-1



Ordering Code	Model	Size/Description	UPC	Wt. (lbs.)	List Price
854.500.050 S	854.500.050 S	2"(50) x 3"(75) Stainless Steel DIN Universal Flange Adapter w/Socket	098268227642	1.87	\$359.50
854.500.075 S	854.500.075 S	3"(75) x 3"(75) Stainless Steel DIN Universal Flange Adapter w/Socket	098268227659	3.28	502.50
854.500.110 S	854.500.110 S	4"(110) x 3"(75) Stainless Steel DIN Universal Flange Adapter w/Socket	098268216745	4.76	610.50
854.500.160 S	854.500.160 S	6"(160) x 3"(75) Stainless Steel DIN Universal Flange Adapter w/Socket	098268216752	8.20	860.50

DIN Socket Flange Adapter - PN16 DIN 2633/EN1092-1



Ordering Code	Model	Size/Description	UPC	Wt. (lbs.)	List Price
854.200.040 S	854.200.040 S	1-1/2"(40) x 5-15/16"(150) Stainless Steel DIN Socket Flange Adapter	098268227390	4.87	\$421.00
854.200.050 S	854.200.050 S	2"(50) x 5-15/16"(150) Stainless Steel DIN Socket Flange Adapter	098268227406	4.63	421.00
854.200.075 S	854.200.075 S	3"(75) x 7-1/4"(185) Stainless Steel DIN Socket Flange Adapter	098268227413	7.50	493.00
854.300.040 S	854.300.040 S	1-1/2"(40) x 6-1/2"(165) Stainless Steel DIN Socket Flange Adapter	098268227567	5.78	453.50
854.300.050 S	854.300.050 S	2"(50) x 6-1/2"(165) Stainless Steel DIN Socket Flange Adapter	098268227604	6.17	453.50
854.300.110 S	854.300.110 S	4"(110) x 8-11/16"(220) Stainless Steel DIN Socket Flange Adapter	098268227611	11.02	594.50

DIN Spigot Flange Adapter - PN16 DIN 2633/EN1092-1



Ordering Code	Model	Size/Description	UPC	Wt. (lbs.)	List Price
854.210.040 S	854.210.040 S	1-1/2"(40) x 5-15/16"(150) Stainless Steel DIN Spigot Flange Adapter	098268227420	4.83	\$421.00
854.210.050 S	854.210.050 S	2"(50) x 5-15/16"(150) Stainless Steel DIN Spigot Flange Adapter	098268227512	5.11	421.00
854.210.075 S	854.210.075 S	3"(75) x 7-1/4"(185) Stainless Steel DIN Spigot Flange Adapter	098268227529	7.61	493.00
854.300.040 S	854.300.040 S	1-1/2"(40) x 6-1/2"(165) Stainless Steel DIN Spigot Flange Adapter	098268227567	5.78	453.50
854.310.050 S	854.310.050 S	2"(50) x 6-1/2"(165) Stainless Steel DIN Spigot Flange Adapter	098268227628	6.17	453.50
854.310.110 S	854.310.110 S	4"(110) x 8-11/16"(220) Stainless Steel DIN Spigot Flange Adapter	098268227635	11.35	594.50

ANSI Socket Flange Adapter - ANSI B16.5



Ordering Code	Model	Size/Description	UPC	Wt. (lbs.)	List Price
854.025.040 S	854.025.040 S	1-1/2"(40) x 6"(152) Stainless Steel ANSI Socket Flange Adapter	098268227260	5.64	\$878.50
854.025.050 S	854.025.050 S	2"(50) x 6"(152) Stainless Steel ANSI Socket Flange Adapter	098268227277	5.56	878.50
854.025.075 S	854.025.075 S	3"(75) x 7-1/2"(191) Stainless Steel ANSI Socket Flange Adapter	098268227291	10.41	1,242.00
854.025.110 S	854.025.110 S	4"(110) x 9"(229) Stainless Steel ANSI Socket Flange Adapter	098268227304	13.54	1,808.00
854.025.160 S	854.025.160 S	6"(160) x 11"(279) Stainless Steel ANSI Socket Flange Adapter	098268216554	14.33	3,790.00

ANSI Spigot Flange Adapter - ANSI B16.5



Ordering Code	Model	Size/Description	UPC	Wt. (lbs.)	List Price
854.035.040 S	854.035.040 S	1-1/2"(40) x 6"(152) Stainless Steel ANSI Spigot Flange Adapter	098268227321	5.64	\$878.50
854.035.050 S	854.035.050 S	2"(50) x 6"(152) Stainless Steel ANSI Spigot Flange Adapter	098268227369	5.27	949.00
854.035.075 S	854.035.075 S	3"(75) x 7-1/2"(191) Stainless Steel ANSI Spigot Flange Adapter	098268227376	9.96	1,242.00
854.035.110 S	854.035.075 S	4"(110) x 9"(229) Stainless Steel ANSI Spigot Flange Adapter	098268227383	12.90	1,808.00

Toilet Adapter



Ordering Code	Model	Size/Description	UPC	Wt. (lbs.)	List Price
855.090.075 S	855.090.075 S	3"(75) Stainless Steel Toilet Adapter	098268227680	0.93	\$187.50
855.090.110 S	855.090.110 S	4"(110) Stainless Steel Toilet Adapter	098268216769	0.86	195.00

Penetrations & Bends



Bulkhead Penetration with Welding Sleeve & Fire Resistant Gasket

Ordering Code	Model	Size/Description	UPC	Wt. (lbs.)	List Price
866.025.040.10FS	866.025.040.10FS	1-1/2"(40) Stainless Steel Bulkhead Penetration w/Welding Sleeve	098268216561	1.83	\$379.50
866.025.050.10FS	866.025.050.10FS	2"(50) Stainless Steel Bulkhead Penetration w/Welding Sleeve	098268216578	2.20	379.50
866.025.075.10FS	866.025.075.10FS	3"(75) Stainless Steel Bulkhead Penetration w/Welding Sleeve	098268216585	3.31	727.00
866.025.110.10FS	866.025.110.10FS	4"(110) Stainless Steel Bulkhead Penetration w/Welding Sleeve	098268216592	4.85	750.50
866.025.160.10FS	866.025.160.10FS	6"(160) Stainless Steel Bulkhead Penetration w/Welding Sleeve	098268216608	8.38	994.00



Wash Basin Penetration with Welding Sleeve

Ordering Code	Model	Size/Description	UPC	Wt. (lbs.)	List Price
866.032.050.05 S	866.032.050.05 S	1-1/4"(32) Stainless Steel Wash Basin Penetration w/Welding Sleeve	098268228052	1.32	\$845.50



Toilet Penetration for Vacuum System with Welding Sleeve

Ordering Code	Model	Size/Description	UPC	Wt. (lbs.)	List Price
867.020.040.10 S	867.020.040.10 S	1-1/2"(40) Stainless Steel Toilet Penetration w/Welding Sleeve	098268228267	1.98	\$219.00
867.020.050.10 S	867.020.050.10 S	2"(50) Stainless Steel Toilet Penetration w/Welding Sleeve	098268228274	1.98	219.00

Deck Penetration with Welding Flange



Ordering Code	Model	Size/Description	UPC	Wt. (lbs.)	List Price
868.100.040FS	868.100.040FS	1-1/2"(40) Stainless Steel Deck Penetration w/Welding Flange	098268216837	0.79	\$343.50
868.105.050FS	868.100.050FS	2"(50) Stainless Steel Deck Penetration w/Welding Flange	098268216844	0.88	343.50
868.115.075FS	868.115.075FS	3"(75) Stainless Steel Deck Penetration w/Welding Flange	098268218516	1.54	404.00
868.125.110FS	868.125.110FS	4"(110) Stainless Steel Deck Penetration w/Welding Flange	098268218824	2.20	479.00

Deck Penetration with Non-Welded Flange



Ordering Code	Model	Size/Description	UPC	Wt. (lbs.)	List Price
868.900.050FS	868.900.050FS	2"(50) Stainless Steel Deck Penetration w/Non-Welded Flange	098268230239	2.62	\$789.00
868.900.075FS	868.900.075FS	3"(75) Stainless Steel Deck Penetration w/Non-Welded Flange	098268244816	3.28	1,221.00
868.900.110FS	868.900.110FS	4"(110) Stainless Steel Deck Penetration w/Non-Welded Flange	098268230345	4.54	1,479.00

Socket Deck Penetration with Welding Sleeve



Ordering Code	Model	Size/Description	UPC	Wt. (lbs.)	List Price
870.000.040FS	870.000.040FS	1-1/2"(40) SS Socket Deck Penetration w/Welding Sleeve & Spigot	098268216851	3.20	\$520.50
870.000.050FS	870.000.050FS	2"(50) SS Socket Deck Penetration w/Welding Sleeve & Spigot	098268218923	3.24	520.50
870.000.075FS	870.000.075FS	3"(75) SS Socket Deck Penetration w/Welding Sleeve & Spigot	098268218930	3.84	619.50
870.000.110FS	870.000.110FS	4"(110) SS Socket Deck Penetration w/Welding Sleeve & Spigot	098268218978	5.05	710.00

90° Long Radius Bend



Ordering Code	Model	Size/Description	UPC	Wt. (lbs.)	List Price
821.000.050 S	821.000.050 S	2"(50) Stainless Steel 90° Radius Bend	098268205305	0.66	\$251.50
821.000.075 S	821.000.075 S	3"(75) Stainless Steel 90° Radius Bend	098268205336	1.10	266.00
821.090.050 S	821.090.050 S	2"(50) Stainless Steel 90° Extra Long Radius Bend	098268206395	1.10	287.50
821.090.075 S	821.090.075 S	3"(75) Stainless Steel 90° Extra Long Radius Bend	098268206937	1.98	394.50
821.090.110 S	821.090.110 S	4"(110) Stainless Steel 90° Extra Long Radius Bend	098268206944	3.55	433.50
821.090.160 S	821.090.160 S	6"(160) Stainless Steel 90° Extra Long Radius Bend	098268206951	7.17	687.00

Penetrations

Deck Penetration with Welding Sleeve



Ordering Code	Model	Size/Description	UPC	Wt. (lbs.)	List Price
872.050.040 S	872.050.040 S	1-1/2"(40) SS Deck Penetration w/Welding Sleeve & Spigot	098268228540	1.83	\$370.50
872.060.050 S	872.060.050 S	2"(50) SS Deck Penetration w/Welding Sleeve & Spigot	098268228557	1.81	370.50
872.076.075 S	872.076.075 S	3"(75) SS Deck Penetration w/Welding Sleeve - 3" OD & Spigot	098268228564	2.18	405.00
872.089.075 S	872.089.075 S	3"(75) SS Deck Penetration w/Welding Sleeve - 3-1/2" OD & Spigot	098268228571	2.76	405.00
872.114.110 S	872.114.110 S	4"(110) SS Deck Penetration w/Welding Sleeve & Spigot	098268228588	3.90	460.00
872.150.125 S	872.150.125 S	5"(125) SS Deck Penetration w/Welding Sleeve & Spigot	098268277111	4.57	713.50
872.168.160 S	872.168.160 S	6"(160) SS Deck Penetration w/Welding Sleeve & Spigot	098268277128	3.95	522.50
872.210.200 S	872.210.200 S	8"(200) SS Deck Penetration w/Welding Sleeve & Spigot	098268277142	7.42	782.50

Deck Penetration with Welding Sleeve

Ordering Code	Model	Size/Description	UPC	Wt. (lbs.)	List Price
875.050.040 S	875.050.040 S	1-1/2"(40) SS Deck Penetration w/Welding Sleeve & Socket - EPDM	098268276800	1.37	\$424.00
875.050.040FS	875.050.040FS	1-1/2"(40) SS Deck Penetration w/Welding Sleeve & Socket - Silicone	098268276824	1.37	401.00
875.060.050 S	875.060.050 S	2"(50) SS Deck Penetration w/Welding Sleeve & Socket - EPDM	098268276831	1.83	269.00
875.060.050FS	875.060.050FS	2"(50) SS Deck Penetration w/Welding Sleeve & Socket - Silicone	098268276848	1.83	247.00
875.076.075 S	875.076.075 S	3"(75) SS Deck Penetration w/Welding Sleeve & Socket - EPDM 3" OD	098268276855	2.24	385.50
875.076.075FS	875.076.075FS	3"(75) SS Deck Penetration w/Welding Sleeve & Socket - Silicone 3" OD	098268276862	2.24	361.00
875.089.075 S	875.089.075 S	3"(75) SS Deck Penetration w/Welding Sleeve & Socket - EPDM 3-1/2" OD	098268276879	2.81	315.00
875.089.075FS	875.089.075FS	3"(75) SS Deck Penetration w/Welding Sleeve & Socket - Silicone 3-1/2" OD	098268276886	2.81	291.00
875.114.110 S	875.114.110 S	4"(110) SS Deck Penetration w/Welding Sleeve & Socket - EPDM 4-1/2" OD	098268276923	4.05	319.50
875.114.110FS	875.114.110FS	4"(110) SS Deck Penetration w/Welding Sleeve & Socket - Silicone 4-1/2" OD	098268276947	4.05	295.50
875.139.110 S	875.139.110 S	4"(110) SS Deck Penetration w/Welding Sleeve & Socket - EPDM 5-1/2" OD	098268276954	3.55	623.50
875.139.110FS	875.139.110FS	4"(110) SS Deck Penetration w/Welding Sleeve & Socket - Silicone 5-1/2" OD	098268276985	3.55	599.50
875.150.125 S	875.150.125 S	5"(125) SS Deck Penetration w/Welding Sleeve & Socket - EPDM	098268277029	4.68	834.50
875.150.125FS	875.150.125FS	5"(125) SS Deck Penetration w/Welding Sleeve & Socket - Silicone	098268277067	4.68	808.00
875.168.160 S	875.168.160 S	6"(160) SS Deck Penetration w/Welding Sleeve & Socket - EPDM	098268277074	3.92	575.50
875.168.160FS	875.168.160FS	6"(160) SS Deck Penetration w/Welding Sleeve & Socket - Silicone	098268277081	3.92	549.00
875.210.200 S	875.210.200 S	8"(200) SS Deck Penetration w/Welding Sleeve & Socket - EPDM	098268277098	7.8	921.50
875.210.200FS	875.210.200FS	8"(200) SS Deck Penetration w/Welding Sleeve & Socket - Silicone	098268277180	7.8	889.50



Aluminum Deck Penetration with Bi-Metal Welding Flange

Ordering Code	Model	Size/Description	UPC	Wt. (lbs.)	List Price
878.105.050 S	878.105.050 S	2"(50) Stainless Steel Deck Penetration w/Bi-Metal Welding Flange	098268228601	1.32	\$677.50
878.115.075 S	878.115.075 S	3"(75) Stainless Steel Deck Penetration w/Bi-Metal Welding Flange	098268228618	1.90	717.50
878.125.110 S	878.125.110 S	4"(110) Stainless Steel Deck Penetration w/Bi-Metal Welding Flange	098268228625	2.80	1,288.00

Lower Parts



Lower Part for Steel Deck with Welding Sleeve

Ordering Code	Model	Size/Description	UPC	Wt. (lbs.)	List Price
470.000.050 S	470.000.050 S	2"(50) 316L SS Steel Deck Marine Drain Lower Part	098268207286	3.81	\$878.50
470.000.075 S	470.000.075 S	3"(75) 316L SS Steel Deck Marine Drain Lower Part	098268229585	3.53	878.50
470.000.110 S	470.000.110 S	4"(110) 316L SS Steel Deck Marine Drain Lower Part	098268229561	3.75	878.50



Lower Part for Steel Deck with Welding Flange

Ordering Code	Model	Size/Description	UPC	Wt. (lbs.)	List Price
470.200.050 S	470.200.050 S	2"(50) 316L SS Steel Deck Marine Drain Lower Part	098268229554	2.87	\$878.50
470.200.075 S	470.200.075 S	3"(75) 316L SS Steel Deck Marine Drain Lower Part	098268229547	2.84	878.50
470.200.110 S	470.200.110 S	4"(110) 316L SS Steel Deck Marine Drain Lower Part	098268229530	2.73	916.00



Lower Part for Steel Deck with Non-Welded Flange

Ordering Code	Model	Size/Description	UPC	Wt. (lbs.)	List Price
470.900.050 S	470.900.050 S	2"(50) 316L SS Steel Deck Marine Drain Lower Part	098268208337	5.18	\$1,713.00
470.900.075 S	470.900.075 S	3"(75) 316L SS Steel Deck Marine Drain Lower Part	098268208382	5.22	1,713.00
470.900.110 S	470.900.110 S	4"(110) 316L SS Steel Deck Marine Drain Lower Part	098268229523	5.14	1,713.00



Lower Part for Steel Deck with Side Outlet with Welding Sleeve

Ordering Code	Model	Size/Description	UPC	Wt. (lbs.)	List Price
475.000.050 S	475.000.050 S	2"(50) 316L SS Steel Deck Marine Drain Lower Part	098268229462	4.08	\$1,179.00
475.000.075 S	475.000.075 S	3"(75) 316L SS Steel Deck Marine Drain Lower Part	098268229455	3.97	1,179.00



Lower Part for Steel Deck with Deep Side Outlet with Welding Sleeve

Ordering Code	Model	Size/Description	UPC	Wt. (lbs.)	List Price
475.100.050 S	475.100.050 S	2"(50) 316L SS Steel Deck Marine Drain Lower Part	098268	4.19	\$1,179.00



Lower Part for Steel Deck with Side Outlet with Welding Flange

Ordering Code	Model	Size/Description	UPC	Wt. (lbs.)	List Price
475.200.050 S	475.200.050 S	2"(50) 316L SS Steel Deck Marine Drain Lower Part	098268200249	2.87	\$927.50
475.200.075 S	475.200.075 S	3"(75) 316L SS Steel Deck Marine Drain Lower Part	098268229431	2.98	927.50



Lower Part for Steel Deck with Side Outlet with Non-Welded Flange

Ordering Code	Model	Size/Description	UPC	Wt. (lbs.)	List Price
475.900.050 S	475.900.050 S	2"(50) 316L SS Steel Deck Marine Drain Lower Part	098268229424	5.18	\$1,713.00
475.900.075 S	475.900.075 S	3"(75) 316L SS Steel Deck Marine Drain Lower Part	098268208412	5.45	1,713.00



Lower Part for Aluminum Deck with Bi-Metal Welding Flange

Ordering Code	Model	Size/Description	UPC	Wt. (lbs.)	List Price
480.200.050 S	480.200.050 S	2"(50) 316L SS Alum. Deck Marine Drain Lower Part	098268229417	2.20	\$2,349.00
480.200.075 S	480.200.075 S	3"(75) 316L SS Alum. Deck Marine Drain Lower Part	098268229400	3.31	2,349.00
480.200.110 S	480.200.110 S	4"(110) 316L SS Alum. Deck Marine Drain Lower Part	098268245769	3.31	2,349.00



Lower Part for Aluminum Deck with Side Outlet with Bi-Metal Welding Flange

Ordering Code	Model	Size/Description	UPC	Wt. (lbs.)	List Price
485.200.050 S	485.200.050 S	2"(50) 316L SS Alum. Deck Marine Drain Lower Part	098268229394	3.31	\$2,676.00
485.200.075 S	485.200.075 S	3"(75) 316L SS Alum. Deck Marine Drain Lower Part	098268214574	3.44	2,676.00

Upper Parts



Upper Part for Tiled or Wood Floors with Side Inlets

Ordering Code	Model	Size/Description	UPC	Wt. (lbs.)	List Price
471.300.110 S	471.300.110 S	4"(110) 316L SS Tiled/Wood Floor Marine Drain Upper Part	098268229516	6.61	\$1,079.00



Upper Part for Resin Floors

Ordering Code	Model	Size/Description	UPC	Wt. (lbs.)	List Price
472.320.110 S	472.320.110 S	4"(110) 316L SS Resin Floor Marine Drain Upper Part	098268229509	1.26	\$667.00



Upper Part with Surface Membrane Clamp for Vinyl Floors

Ordering Code	Model	Size/Description	UPC	Wt. (lbs.)	List Price
473.300.110 S	473.300.110 S	4"(110) 316L SS Vinyl Floor Marine Drain Upper Part	098268245769	1.76	\$367.00



Upper Part with Welding Sleeve for Vinyl Floors

Ordering Code	Model	Size/Description	UPC	Wt. (lbs.)	List Price
473.301.110 S	473.301.110 S	4"(110) 316L SS Vinyl Floor Marine Drain Upper Part	098268229486	1.26	\$920.50

Water Traps



Water Traps

Ordering Code	Model	Size/Description	UPC	Wt. (lbs.)	List Price
502.050.110 MS	502.050.110 MS	4-1/4"(108) 316L SS Two-Part Water Trap	098268229363	0.79	\$233.50
503.000.110 CR	503.000.110 CR	4-1/4"(108) 316L SS Removable Multi-Part Water Trap	098268229356	0.86	617.00



A **WATTS** Brand